

B

STMI
Team



STMI
Team

Designazione
Designation
Bezeichnung

B1

SCHEDE TECNICHE RIDUTTORI
GEARBOXES TECHNICAL SHEETS
TECHNISCHE DATENBLÄTTER GETRIEBE



SIZE	 EX Series					 EXB Series				Reference Torque Nm	PAGE
	1	2	3	4	range IR	2	3	4	range IR		
10	101	102	103	104	3.48-2687	102	103	104	10.01-2559	1000	B14
20	201	202	203	204	3.48-2687	202	203	204	10.01-2559	2000	B16
25	251	252	253	254	3.48-2135	252	253	254	10.01-2051	2500	B18
30	301	302	303	304	3.60-2799	302	303	304	10.35-2666	3000	B20
35	351	352	353	354	3.60-2314	352	353	354	10.35-2204	3500	B22
40	—	402	403	404	12.5-2799	—	403	404	36.0-2666	4000	B24
50	501	502	503	504	3.60-2799	502	503	504	9.11-2666	5000	B26
70	704	702	703	704	3.60-1595	702	703	704	9.11-1519	7000	B28
80	801	802	803	804	3.50-2818	802	803	804	8.85-2685	8000	B30
90	—	902	903	904	12.6-2818	—	903	904	36.2-2685	9000	B32
95	—	952	953	954	12.6-2330	—	953	954	36.2-2219	9500	B34
100	101	1002	1003	1004	3.50-2818	1002	1003	1004	8.85-2685	10000	B36
150	1501	1502	1503	1504	3.72-2422	1502	1503	1504	9.41-2307	15000	B38
180	—	1802	1803	1804	15.8-2041	—	1803	1804	40.1-1944	18000	B40
200	2001	2002	2003	2004	4.40-1163	2002	2003	2004	11.1-1108	20000	B42
250	2501	2502	2503	2504	3.63-2447	2502	2503	2504	9.17-2330	25000	B44
280	—	2802	2803	2804	12.7-2447	—	2803	2804	32.1-2341	28000	B46
300	3001	3002	3003	3004	3.52-2289	3002	3003	3004	8.90-2190	30000	B48
350	3501	3502	3503	3504	4.04-2883	—	3503	3504	36.8-2758	35000	B50
360	—	3602	3603	3604	15.0-2478	—	3603	3604	38.0-2371	36000	B52
420	4201	4202	4203	4204	4.18-2019	—	4203	4204	39.3-1932	42000	B54
600	—	6002	6003	6004	15.6-2019	—	6003	6004	39.3-1932	60000	B56
650	6500	6502	6503	6504	4.18-2039	—	6503	6504	38.3-1873	65000	B58
800	—	8002	8003	8004	15.2-2039	—	8003	8004	38.3-1873	80000	B60
850	8501	8502	8503	8504	4.18-1907	—	8503	8504	37.2-1752	85000	B62
1000	10001	10002	10003	10004	4.04-2341	—	10003	10004	36-2150	100000	B64
1200	12001	12002	12003	12004	4.18-2402	—	—	12004	149.7-2207	120000	B66
1500	—	15002	15003	15004	16.3-2948	—	—	15004	144.7-2708	150000	B68
1600	16001	16002	16003	16004	4.04-2065	—	—	16004	159.1-1896	160000	B70
2000	20001	20002	20003	20004	4.18-1631	—	—	20004	160.3-1550	200000	B72
2500	—	—	25003	25004	61.3-2002	—	—	25004	155.0-1902	250000	B74
2600	26001	26002	26003	26004	4.04-1873	—	—	26004	150.5-1779	260000	B76
3000	—	—	30003	30004	16.9-2002	—	—	30004	155.0-1902	300000	B78
3100	31001	31002	31003	31004	4.18-1873	—	—	31004	150.5-1779	310000	B80
3200	—	32002	32003	32004	17.5-1922	—	—	—	—	320000	B82
3700	37001	37002	37003	37004	4.17-1991	—	—	—	—	370000	B83
4500	45001	45002	45003	45004	4.17-1615	—	—	—	—	450000	B84
5500	55001	55002	55003	55004	4.17-1398	—	—	—	—	550000	B85
6800	68001	68002	68003	68004	4.17-1515	—	—	—	—	680000	B86
7500	—	75002	75003	75004	15.0-779.5	—	—	—	—	750000	B87
8000	80001	80002	80003	80004	3.70-956.6	—	—	—	—	800000	B88



1.1 Designazione

1.1 Designation

1.1 Bezeichnung

EX **B** **10** **1** **-** **P** **D**

CODE:
Example of Order

Maschine	Centerline Orientation	Size	N° of reductions	Combined gearbox	Output Version	Output Shaft
00-M	01-CO	02-SIZE	03-NOR	04-CG	05-OV	06-OS

WEB:
Reference Designation

- EX**
- 10
 - 20
 - 25
 - 30
 - 35
 - 40
 - 50
 - 70
 - 80
 - 90
 - 95
 - 100
 - 150
 - 180
 - 200
 - 250
 - 280
 - 300
 - 350
 - 360
 - 420
 - 600
 - 650
 - 800
 - 850
 - 1000
 - 1200
 - 1500
 - 1600
 - 2000
 - 2500
 - 2600
 - 3000
 - 3100
 - 3200
 - 3700
 - 4500
 - 5500
 - 6800
 - 7500
 - 8000

63
Example
EXV

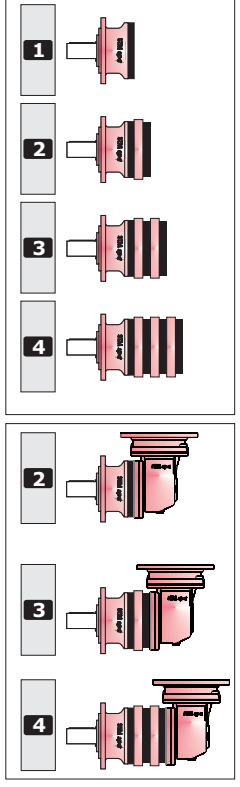
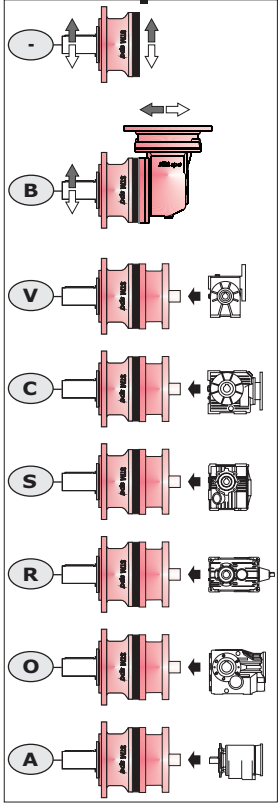

Standard male output shaft Size 10 ... 150	RN.-LN RD		
Reinforced male output shaft M. - Size 10 ... 80 L. - Size 100 MX. - Size 30 ... 70	MN.-LN. MXN. MXD MD-LD		
Oversized flange male output shaft Size 30 ... 300	TN. TD		
Male shaft ring gear flange H. - Size 150-180-200-250-280-300 X. - Size 150-180-200	HN. XN. XD HD		
Male shaft ring gear flange NOTE: Size/7500-8000 SN1-Version FSR+N SD-Version FSR+Q	SN. SBN. SBD SD		
Male square shaft ring gear flange NOTE: SQ-Version FSR+Q Size 7500-8000	SQ		
Drivewheel flange connected ring gear flange NOTE: SFD-Version FSR+FD Size 1600...8000	SFD		
Cast foot mount Size 10 ... 200	PN. PD		
Bolted on foot Size 150 ... 4500	PHN. PXN. PSN. PSBN. PHD PXD PSD PSBD		
Female keyed shaft with shaft front flange Size 10 ... 100	FC		
Female keyed shaft ring gear flange Size 30 ... 280	FCB		C - keyed shaft
Female spined shaft ring gear flange Size 10 ... 100	F		
Female spined shaft ring gear flange Size 30-40-50-70	FP		
Female spined shaft ring gear flange Size 10 ... 8000	FS FSB		
Female spined shaft ring gear flange Size 420 ... 8000	FSR		
Female spined shaft ring gear flange Size 80-90-100	FB		(CD) - Spined shaft
Standard shrink disc shaft Size 10 ... 200	FU		
Shrink disc shaft with oversized flange Size 150 ... 300	TU		
Shrink disc shaft ring gear flange Size 150 ... 300	HU		
Shrink disc shaft ring gear flange Size 350 ... 8000	SU		U - Shrink disc

N - Male keyed shaft
D - Male spined shaft
Q - Male square shaft
FD - Drivewheel flange

N - Male keyed shaft
D - Male spined shaft

1.1 Designazione

1.1 Designation

1.1 Bezeichnung

63.4 Z1A1 - CA04 - VT A M11 FD -

Reduction ratio	Type Brake	Input Version	Input Shaft	IEC type and Input Shaft	Options	Mounting Version	Mounting positions	Accessories	Position Terminal Box
07-IR	8a-TBZ	09-IV	10-IS	11-IECT	13-OPT	14-MV	15-MP	16-ACC.	17 PMT

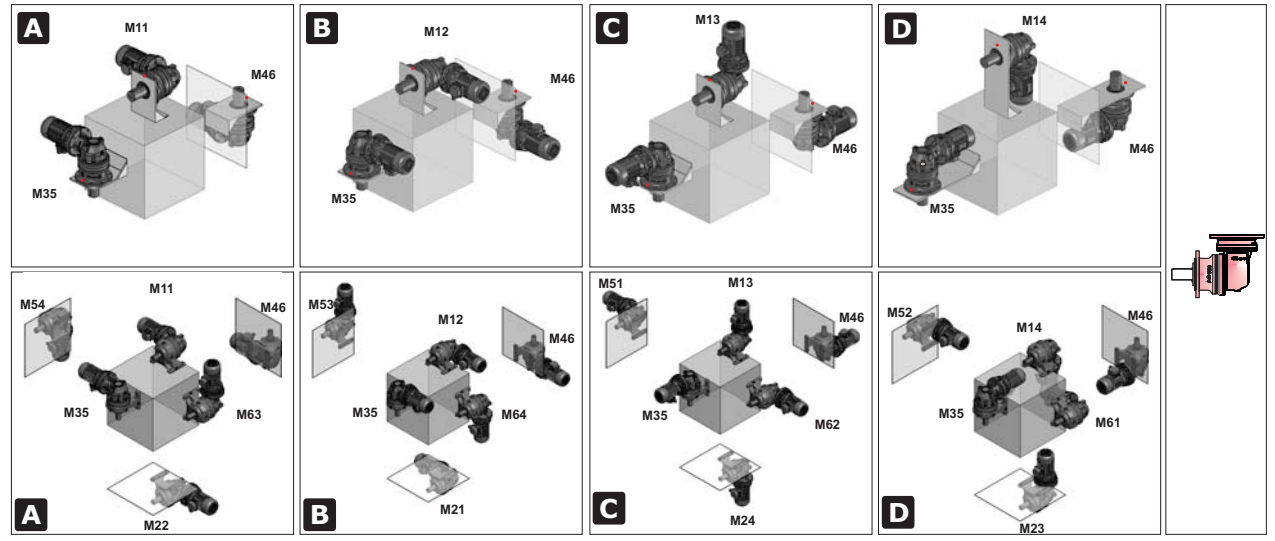
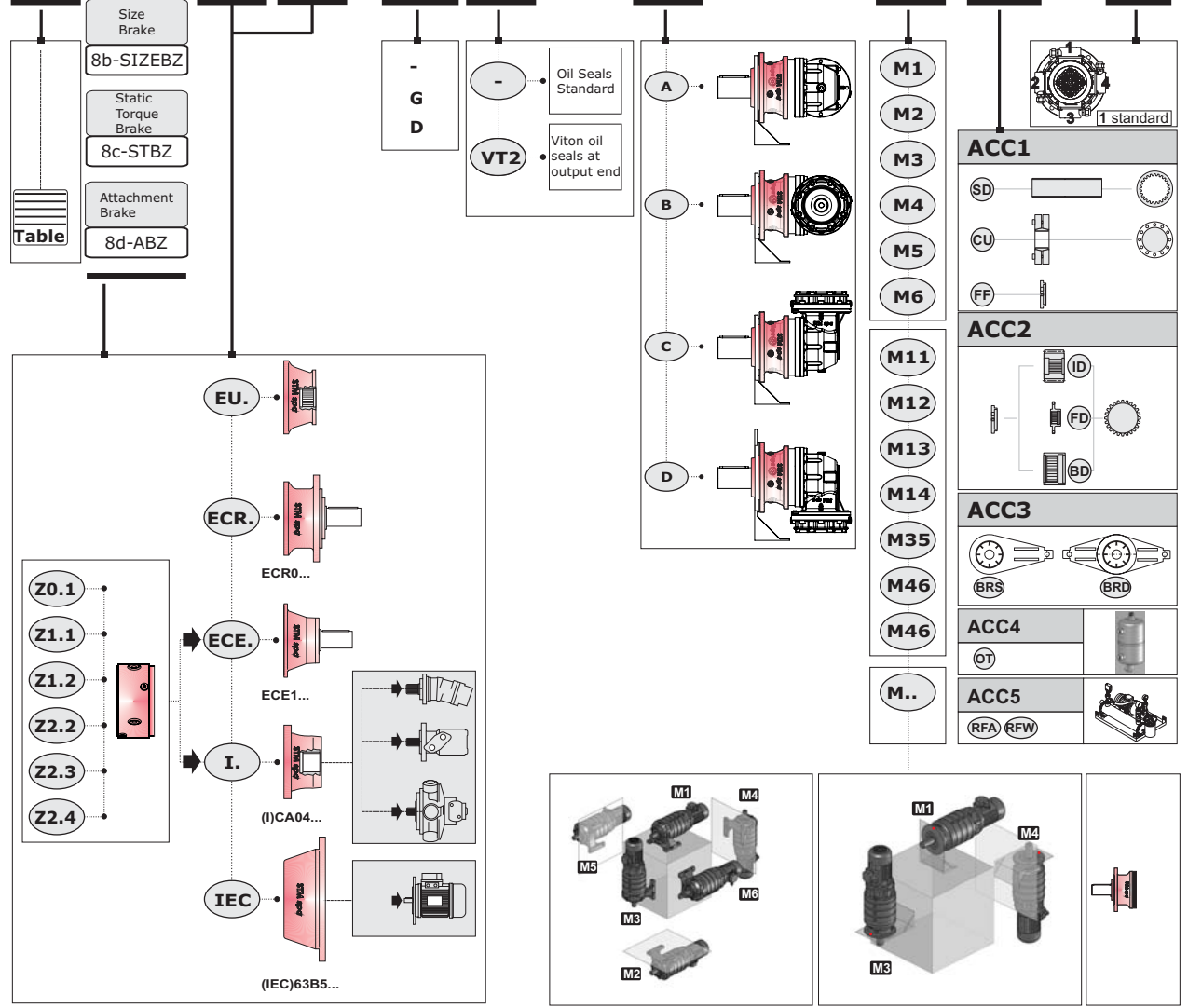

1.1 Designazione

1.1 Designation

1.1 Bezeichnung

00 M - Macchina

M - Maschine

M - Getriebe

EX

01 CO - Posizione Assi

CO - Centerline Orientation

CO - Bauform getriebestufen

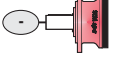
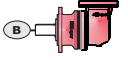
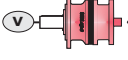
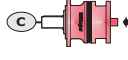
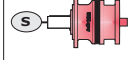
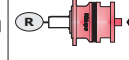
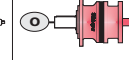
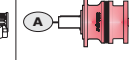
							
Lineare In line Linear	Ortagonale Bevelgear Kegelgetriebe	Ortagonale Bevelgear Kegelgetriebe	Ortagonale Bevelgear Kegelgetriebe	Ortagonale Bevelgear Kegelgetriebe	Ortagonale Bevelgear Kegelgetriebe	Ortagonale Bevelgear Kegelgetriebe	Lineare In line Linear

02 SIZE - Grandezza







SIZE - Size

SIZE - Größe

03 NOR - N° Stadi

NOR - N° of reductions

NOR - N° Anzahl der stufen

								
10	101	102	103	104		102	103	104
20	201	202	203	204		202	203	204
25	251	252	253	254		252	253	254
30	301	302	303	304		302	303	304
35	351	352	353	354		352	353	354
40	—	402	403	404		—	403	404
50	501	502	503	504		502	503	504
70	704	702	703	704		702	703	704
80	801	802	803	804		802	803	804
90	—	902	903	904		—	903	904
95	—	952	953	954		—	953	954
100	101	1002	1003	1004		1002	1003	1004
150	1501	1502	1503	1504		1502	1503	1504
180	—	1802	1803	1804		—	1803	1804
200	2001	2002	2003	2004		2002	2003	2004
250	2501	2502	2503	2504		2502	2503	2504
280	—	2802	2803	2804		—	2803	2804
300	3001	3002	3003	3004		3002	3003	3004
350	3501	3502	3503	3504		—	3503	3504
360	—	3602	3603	3604		—	3603	3604
420	4201	4202	4203	4204		—	4203	4204
600	—	6002	6003	6004		—	6003	6004
650	6500	6502	6503	6504		—	6503	6504
800	—	8002	8003	8004		—	8003	8004
850	8501	8502	8503	8504		—	8503	8504
1000	10001	10002	10003	10004		—	10003	10004
1200	12001	12002	12003	12004		—	—	12004
1500	—	15002	15003	15004		—	—	15004
1600	16001	16002	16003	16004		—	—	16004
2000	20001	20002	20003	20004		—	—	20004
2500	—	—	25003	25004		—	—	25004
2600	26001	26002	26003	26004		—	—	26004
3000	—	—	30003	30004		—	—	30004
3100	31001	31002	31003	31004		—	—	31004
3200	—	32002	32003	32004		—	—	—
3700	37001	37002	37003	37004		—	—	—
4500	45001	45002	45003	45004		—	—	—
5500	55001	55002	55003	55004		—	—	—
6800	68001	68002	68003	68004		—	—	—
7500	—	75002	75003	75004		—	—	—
8000	80001	80002	80003	80004		—	—	—

1.1 Designazione

1.1 Designation

1.1 Bezeichnung

04 CG- Riduttore Accoppiato

CG - Combined gearbox

CG - Kombiniertes Getriebe

	1								2								3								4							
10	101									102										103									104			
20		201								202										203									204			
25			251							252										253									254			
30				301						302										303									304			
35					351					352										353									354			
40										402										403									404			
50				501						502										503									504			
70					701					702										703									704			
80						801				802										803									804			
90										902										903									904			
95										952										953									954			
100							1001			1002										1003									1004			
150								1501		1502										1503									1504			
180										1802										1803									1804			
200									2001						2002					2003									2004			
250										2501						2502					2503								2504			
280																2802					2803								2804			
300										3001						3002					3003								3004			
350																3502					3503								3504			
360																	3602				3603											
420																	4202				4203								4204			
600																	6002				6003											
650																		6502				6503							6504			
800																		8002				8003										
850																			8502				8503						8504			
1000																													10004			
1200																													12004			



EXV 50																													
EXV 63																													
EXV 70																													
EXV 85																													
EXV 110																													
EXV 130																													
EXV 150																													
EXV 180																													
EXC 50																													
EXC 70																													
EXC 85																													
EXC 110																													
EXS 35																													
EXS 45																													
EXR 704																													
EXR 708																													
EXR 712																													
EXR 716																													
EXR 720																													
EXO 132																													
EXO 150																													
EXO 170																													
EXO 190																													
EXA 35																													
EXA 41																													
EXA 45																													
EXA 50																													

1.1 Designazione

05 OV - Versione Uscita

06 OS - Albero Uscita

1.1 Designation

OV - Output Version

OS - Output Shaft

1.1 Bezeichnung

OV - Abtriebausführung

OS - Abtriebswelle

Versioni/ versions / Ausführungen

FS - FCB

NOTA - Solo per **EXB**

- Non disponibili per le grandezze:
502 - 702 - 802 - 1002

NOTA - Only for **EXB**

- Not available for size:
502 - 702 - 802 - 1002

NOTA - Nur für **EXB**

- Nicht verfügbar für Größe:
502 - 702 - 802 - 1002

Versioni/ versions / Ausführungen

PHD - PHN1

PXD - PXN1

NOTA - Solo per **EXB**

- Non disponibili per le grandezze:
1502 - 2002 - 2502 - 3002

NOTA - Only for **EXB**

- Not available for size:
1502 - 2002 - 2502 - 3002

NOTA - Nur für **EXB**

- Nicht verfügbar für Größe:
1502 - 2002 - 2502 - 3002

25 20 10	70 50 40 35 30	80	100 95 90	200 180 150	280 250	300	350	360 420	650 600	850 800	1200 1000	2000 1600 1500	3200 3100 3000 2600 2500	4500 3700	5500	8000 7500 6800				
ø38-ø40 ø42 ø50 ø50 ø48	ø60 ø65 ø50	ø80	ø90 ø100	ø90 ø100													RN1-LN1 RN2 RN3 RN4		 N - Male keyed shaft D - Male spined shaft Q - Male square shaft FD - Drivewheel flange	
B40x36	B58x53	B70x64	B80x74	B80x74													RD			
ø60 ø65 ø50	ø60 ø65	ø80	ø90														MN1 MN2-LN2 MN3 MXN1 MXN2			
	ø60 ø65																MXD MD-LD			
B58x53	B58x53	B70x64	B80x74															TN1 TN2 TN3 TN4		
ø38 ø42 ø50 ø50 ø48	ø60 ø65 ø50	ø80	ø90 ø100	ø90 ø100	ø110	ø120												TD		
B40x36	B58x53	B70x64	B80x74	B80x74	B100x94	W120x3												HN1 HN2 XN1 XN2		
			ø90 ø100	ø110	ø120													XD HD		
			B100x94 B80x74	B100x94	W120x3													SN1 SN2 SBN1 SBN2		
							ø120 ø140 ø140	ø120 ø140 ø140	ø160	ø170	ø180	ø200	ø230	ø290	ø340	ø340		SBD		
							W120x3 W120x3	W120x3 W120x3	W150x5	W170x5	W170x5	W200x5	W220x5	W280x8	W340x8	W340x8		SD		
																		SQ		
																		SFD		
ø38 ø42 ø50 ø50 ø48	ø60 ø65	ø80	ø90	ø90 ø100														PN1 PN2 PN3 PN4		
B40x36	B58x53	B70x64	B80x74	B80x74														PD		
			ø90 ø100	ø110	ø120													PHN1 PHN2 PXN1 PXN2		
			ø100															PSN1 PSN2 PSBN1 PSBN2		
			B80x74 B100x94	B100x94	W120x3		ø120 ø140 ø140	ø120 ø140 ø140	ø160	ø170	ø180	ø200	ø230	ø290	ø290			PHD PXD PSD PSBD		
							W120x3 W120x3	W120x3 W120x3	W150x5	W170x5	W170x5	W200x5	W220x5	W280x8	W280x8					

25 20 10	70 50 40 35 30	80	100 95 90	200 180 150	280 250	300	350	360 420	650 600	850 800	1200 1000	2000 1600 1500	3200 3100 3000 2600 2500	4500 3700	5500	8000 7500 6800				
ø35	ø50	ø65	ø75															FC		 C - keyed shaft CD - Spined shaft U - Shrink disc
	ø65	ø80	ø90	ø100	ø110													FCB		
A40x36	A58x53	A70x64	A80x74															F		
	A58x53																	FP		
A40x36	A58x53	A70x64	A80x74	A80x74	A100x94	N120x5	N120x3			N150x5	N170x5	N200x5	N210x5	N240x5	N280x8	N300x8	N340x8	FS		
																		FSB		
																		FSR		
		A70x64	A70x74															FB		
ø50	ø75	ø90	ø100	ø120														FU		
				ø120	ø130	ø135													TU	
				ø120	ø130	ø135													HU	
							ø145	ø145	ø165	ø180	ø220	ø240	ø260	ø290	ø310	ø350		SU		

1.1 Designazione

1.1 Designation

1.1 Bezeichnung

09 IV - Versione Entrata

IV - Input Version

IV - Antriebsausführung

10 IS - Albero Entrata

IS - Input Shaft

IS - Antriebswelle

Descrizione Predisposizione Adjustment description Beschreibung Vorbereitung	09 IV	10 IS	
Senza Flangia Motore Beschreibung Vorbereitung Ohne Motorenflansch	PR	-	
EX. Combinati . EX. Combined Gearbox. EX Kombiniert.			
Universale Universal	EU	-	
Albero maschio cilindrico con linguetta Support with keyed cylindrical shaft Vollwelle mit Passfeder	ECE	1A 2A 3 ...	
Albero maschio cilindrico con linguetta - Rinforzata Reinforced support with keyed cylindrical shaft Vollwelle mit verstaerkter Passfeder	ECR	1 2 3 ...	
Motore Elettrico-IEC Elektromotor-IEC Electric motor-IEC	IEC	63 71 80 ...	
Motore Idraulico Hydromotor Hydraulic motor	I	CA04 CA05 CA06 ...	

Descrizione Predisposizione Adjustment description Beschreibung Vorbereitung	08a	08b	08c								08d	09-IV 10-IS
Freno Idraulico Hydraulic Brake Lamellen Brensen	TBZ Tipo Type Typ	SIZEBZ Grandezza Size Größe	STBZ Coppia Frenatura Static Torque Mittleres Stützmomenten								ABZ Accoppiamento Attachment Verbindung	
			A	B	C	D	E	F	G	H		
Z.	Z	0	60 Nm	100 Nm	160 Nm	200 Nm	280 Nm	330 Nm	430 Nm	520 Nm	1 (10)	Sezione D
		1	90 Nm	140 Nm	240 Nm	300 Nm	430 Nm	550 Nm	—	—	1 (10-20-25) 2 (30-50-70)	
		2	400 Nm	650 Nm	800 Nm	1000 Nm	1250 Nm	1500 Nm	1700 Nm	—	2 (30-50-70) 3 (80-100) 4 (150)	

Per Dimensioni e Predisposizioni disponibili vedere Sezione D
See section D for adjustments and dimensions available
Fuer Abmessungen und moegliche Vorbereitungen siehe Sektion D

07 IR- Rapporto di riduzione

IR - Reduction ratio

IR - Übersetzungsverhältnis

(Vedi prestazioni). Tutti i valori dei rapporti sono approssimati. Per applicazioni dove necessita il valore esatto consultare il ns. servizio tecnico.

(See ratings). Ratios are approximate values. If you need exact values for a specific application, please contact our Engineering.

(Siehe "Leistungen"). Bei allen Werten der Übersetzungen handelt es sich um approximative Wertangaben. Bei Applikationen, bei denen die exakte Wertangabe erforderlich ist, muss unser Technischer Kundendienst konsultiert werden.

1.1 Designazione

1.1 Designation

1.1 Bezeichnung

11 IECT - Tipo IEC e Albero Entrata

IECT - IEC type and Input Shaft

IECT - IEC Typ und Antriebswelle

11 IECT	Descrizione	EX EXB	EX.					
			Combinato / Combined / Kombiniert					
			EXV	EXC	EXS	EXR	EXA	EXO
-	Con campana senza giunto Motor bell without coupling mit Glocke ohne Kupplung					RXP - RXO 704 - 708 712 - 716		-
G	Con giunto With coupling mit Kupplung		50 - 63		35 - 45	RXP - RXO 704 - 708 712 - 716	2C - 41 2C - 45	*
D	Accoppiamento diretto Direct coupling direkte Passung		50 - 63 70 - 85 110 - 130 150 - 180	50 - 70 85 - 110		RXO 704 - 708 712 - 716	35 3C - 41 3C - 45 50	*

- * Contattare nostro ufficio tecnico commerciale
- * Please, contact our technical sales dept.
- * Bitte setzen Sie sich mit unserer technischen Abteilung in Verbindung

13 OPT - Opzioni - Materiale degli anelli di tenuta

OPT - Options - Materials of Seals

OPT - Optionen - Dichtungstoffe

(VT1 - NBR2)	Tenute STANDARD	Oil Seals Standard	Ölabdichtungen Standard
VT2	Paraoli in viton in uscita	Viton oil seals at output end	Ölabdichtungen aus Viton im Abtrieb

NBR2	Paraoli in NBR in uscita	NBR oil seals at output end	Ölabdichtungen aus NBR im Abtrieb
VT1	Paraoli in viton in entrata	Viton oil seals at input end	Ölabdichtungen aus Viton im Antrieb
VT2	Paraoli in viton in uscita	Viton oil seals at output end	Ölabdichtungen aus Viton im Abtrieb

14 MV - Versione di Montaggio

MV - Mounting Version

MV - Montagausführung

APPLICABILITA': solo per prodotti combinati esempio EXB-EXV - EXC - EXS - EXR - EXO - EXA.
La versione di montaggio definisce la posizione reciproca del riduttore EX con il riduttore combinato.
Lo schema grafico è riportato nella Sezione V.

Applicability: only for combined gearboxes type EXB - EXV - EXC - EXS - EXR - EXO and EXA.
The mounting position define the mountin position between the two gearboxes.
The graphic sketch is to the section V.

Anwendung: nur für kombinierte Getriebe Typen EXB - EXV - EXC - EXS - EXR - EXO - EXA.
Die Montageversion zeigt die Position beider Getriebe.
Die Grafische Ausfuehrung finden Sie in der Sektion V.

Lato flangia uscita riduttore combinato Combined gearbox output flange side Montageseite Abtriebsflansch für kombinierte Getriebe	Descrizione Description Beschreibung	EX.						
		Combinato / Combined / Kombiniert						
		EXB	EXV	EXC	EXS	EXR	EXO	EXA
DX	flangia destra Right flange Flansch rechts	A - B - C - D						
SX	flangia sinistra Left flange Flansch links	-			L - M - N - O			-

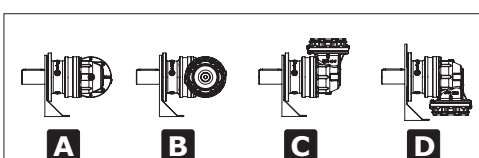
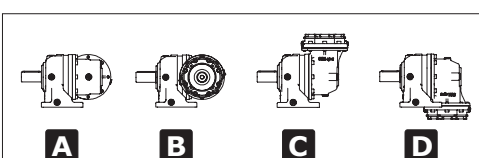
EXB	
Tipo Supporto Uscita / Output support type / Abtriebselement	
Con Flangia-With Flange-Mit Flansch (Example output version R.)	Con piede - With foot - Mit Fuß (Example output version P.)
A - B - C - D	A - B - C - D
	

1.1 Designazione

1.1 Designation

1.1 Bezeichnung

15 MP - Posizioni di montaggio

MP - Mounting positions

MP - Einbaulagen

Dopo aver definito la versione di montaggio è necessario che sia indicata la posizione in cui il riduttore sarà montato.

After to have defined the mounting position it's necessary to show the position whose the gearbox will be mounted.

Nachdem die Einbaulage mitgeteilt wurde, muessen auch die Positionen der 2 Getriebe definiert werden.

Il primo numero indica la posizione di montaggio in cui si viene a trovare il riduttore EX mentre il secondo numero la posizione in cui si trova il riduttore combinato.

The first number is the EX mounting position while the second number is the combined gearbox position.

Die erste Nummer ist die Einbaulage des EX Getriebe, die zweite das kombinierte Getriebe. Bitte das Oe dementsprechend fuellen.

Attenersi a questi indicazioni per il riempimento dei rispettivi riduttori.

Follow this instructions for to fill the gearboxes.

Die Grafische Ausfuehrung finden Sie in der Sektion V.

Lo schema grafico è riportato nella Sezione V.

On the section V there is the graphic sketch.

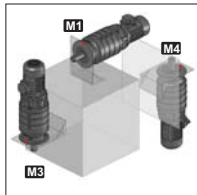
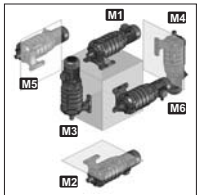
EX	
Tipo Supporto Uscita / Output support type / Abtriebselement	
Con Flangia-With Flange-Mit Flansch (Example output version R.)	Con piede - With foot - Mit Fuß (Example output version P.)
M1-M2-M3	M1-M2-M3-M4-M5-M6
	

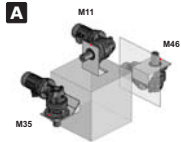
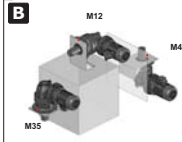
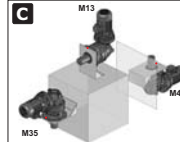
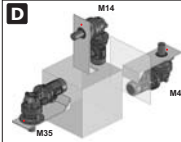
EXB			
Tipo Supporto Uscita / Output support type / Abtriebselement			
Con Flangia-With Flange-Mit Flansch (Example output version R.)			
M11-M35 -M46 (MV=A)	M12-M35 -M46 (MV=B)	M13-M35 -M46 (MV=C)	M11-M35 -M46 (MV=D)
			

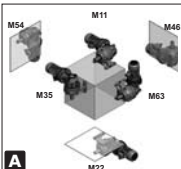
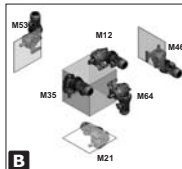
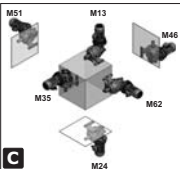
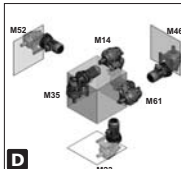
EXB			
Tipo Supporto Uscita / Output support type / Abtriebselement			
Con piede - With foot - Mit Fuß (Example output version P.)			
M11-M22 -M35-M46-M54-M63(MV=A)	M12-M21 -M35-M46-M53-M64(MV=B)	M13-M24 -M35-M46-M51-M62(MV=C)	M14-M23 -M35-M46-M52-M61(MV=D)
			

EX. (Combinato / Combined / Kombiniert)		
Tipo Supporto Uscita / Output support type / Abtriebselement	P.	R - M - H - FB - FS - FP
Designazione / Designation / Bezeichnung	M11 - M21 - M35 - M51 - M61 M12 - M22 - M46 - M52 - M62 M13 - M23 - M36 - M53 - M63 M14 - M24 - M45 - M54 - M64	M11 - M12 - M13 - M14 M35 - M46 - M36 - M45
Lo schema grafico è riportato nella Sezione V / On the section V there is the graphic sketch / Die Grafische Ausfuehrung finden Sie in der Sektion V		

16 ACC. - Accessori

ACC. - Accessories

ACC. - Zubehör

16a ACC1		Accessori -Estremità uscita / Accessories - Output Configuration / Zubehör - Enden der Ausgangswellen		
Code	Descrizione	Description	Beschreibung	
SD	Barra scanalata - SD	Splined - SD	mit Keilende - SD	
CU	Unità di bloccaggio	Shrink disc	Schrumpfscheibe	
FF	KIT - Fondello - FF	Kit - Cover -FF	KIT - Deckel - FF	

Vedi Sezione C / To see section C / Sie in der Sektion C

16b ACC2		Accessori - Estremità Dentate D / Accessories - Output Configuration - Accessories - Splined D / Zubehör - Enden der Ausgangswellen mit Keilende D		
Code	Descrizione	Description	Beschreibung	
ID.	Pignone dentato	Output pinions	Abtriebsritzel	
FD	Estremità scanalata albero lento flangia brocciata	Splined output shaft and broached flange	Abtriebswelle mit Keilende und geräumtem Flansch	
BD	Bussola dentata	BUSHING	BUCHSE	

Vedi Sezione C / To see section C / Sie in der Sektion C

ID. OP - Pignoni dentati

OP - Output pinions

OP - Abtriebsritzel

Modulo Normale Normal module Normales Modul		Numero Denti Number of Teeth Zahneanzahl		Larghezza Fascia Teeth width Zahnbreite		Coefficiente di Spostamento Addendum modification coefficient Profilverschiebungsfaktor	
Modulo Module Modul	Designazione Designation Bezeichnung	N° Denti Teeth nr. Zahne Nr.	Designazione Designation Bezeichnung	Larghezza Fascia Widht Zahnbreite	Designazione Designation Bezeichnung	Designazione Designation Bezeichnung	X=(+ or - real value)
4.5	A	10	10	40-49	A	1...9	
5	B	11	11	50-59	B		
6	C	12	12	60-69	C		
8	D	13	13	70-79	D		
10	E	14	14	80-89	E		
12	F	15	15	90-99	F		
14	G	16	16	100-109	G		
16	H	17	17	110-119	H		
18	I	18	18	120-129	I		
20	L	19	19	130-139	L		
		20	20	140-149	M		
		21	21	150-159	N		
				160-169	O		
				170-179	P		
				180-189	Q		
				190-199	R		
				200-209	S		
				210-219	T		
				220-229	U		
				230-239	V		
				240-249	W		
				250-259	X		
				260-269	Y		
				270-279	Z		

Esempio:
Se si vuole un pignone dentato per rotazione con modulo normale 16, numero denti 21, larghezza fascia 146 e coefficiente di spostamento di profilo di + 0.5 in designazione si dovrà riportare:
ID H21M6 X+0.5

For example:
If you require a rotation pinion with normal module 16, teeth number 21, width 146 and addendum modification coefficient +0.5 the description will be:

ID H21M6 X+0.5

Z. B. Wenn Sie einen Ritzel fuer Drehung mit normalen Modul 16, Zahneanzahl 21, Breite 146 und Profilverschiebungsfaktor +0.5 benoetigen, wird die Beschreibung folgend sein:

ID H21M6 X+0.5

16 ACC. - Accessori

ACC. - Accessories

ACC. - Zubehör

16c ACC3		Accessori - Versioni pendolari / Accessories - Shaft Mounted Version - Zubehör - Aufsteckausführung		
Code	Descrizione	Description	Beschreibung	
 BRD	Braccio Reazione Doppio	Torque arm - Double	Drehmomentstütze - Doppel	
 BRS	Braccio Reazione Semplice	Torque arm - Single	Drehmomentstütze - Normal	
Vedi Sezione C / To see section C / Sie in der Sektion C				

16d ACC4		Accessori - Vaso Espansione / Accessories - Expansion tank / Zubehör - Expansionsfäß		
Code	Descrizione	Description	Beschreibung	
 OT.	Vaso espansione - ...litri	Expansion tank - ...l	Expansionsfäß - ...,l	
Vedi Sezione E / To see section E / Sie in der Sektion E				

16e ACC5		Accessori - sistema con scambiatore / Accessories - Cooling Unit / Zubehör - Kühlanlage		
Code	Descrizione	Description	Beschreibung	
 RFA.	RFA. - sistema con scambiatore aria-olio	RFA. - air/oil exchanger	RFA. - System mit Luft-/Ölaustauscher	
 RFB.	RFB. - sistema con scambiatore acqua-olio	RFB. - water/oil exchanger	RFB. - System mit Wasser-/Ölaustauscher	
Vedi Sezione E / To see section E / Sie in der Sektion E				

17 PMT - Posizioni della Morsettieria

PMT - Position Terminal Box

PMT - Montagposition Klemmenkasten

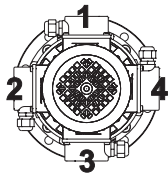
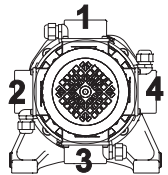
Tipo Supporto Uscita / Output support type / Abtriebselement	
Con Flangia-With Flange-Mit Flansch (Example output version R.)	Con piede - With foot - Mit Fuß (Example output version P.)
	

[2, 3, 4] Posizione della morsettieria del motore se diversa da quella standard (1)..

[2, 3, 4] Position of the motor terminal box if different from the standard one (1).

Montageposition Klemmenkasten [2, 3, 4], wenn abweichend von Standardposition [1] (für Motorgetriebe).



1.2 Prestazioni

1.2 Performances

1.2 Leistungen

EX		$n_2 \times h$								10000 Hours Life				T_{max} [Nm]
		T_N [Nm]								n_1 [rpm]	n_2 [rpm]	T_N [Nm]	P_1 [kW]	
Stadio Stage Stufe	ir	10000	20000	50000	100000	500000	1000000	2000000						
1	3.48	1021	962	962	962	924	750	609	1400	402.30	494	21.45	1800	
	4.26	1326	1250	1250	1250	907	737	598		328.64	516	18.31	2000	
	5.77	1074	997	898	830	691	638	581		242.63	548	14.35	1500	
	7.20	682	630	568	525	437	408	400		194.44	400	8.40	1100	
2	12.11	975	920	920	919	918	750	609	1400	115.61	718	9.25	1800	
	14.84	1272	1199	1199	1199	907	737	598		94.34	750	7.88	2000	
	18.17	1266	1194	1194	1193	907	737	598		77.05	797	6.84	2000	
	20.08	963	908	908	908	907	750	609		69.72	836	6.49	1800	
	24.60	1258	1186	1186	1186	907	737	598		56.91	872	5.53	2000	
	30.69	1253	1181	1181	1181	907	737	598		45.62	932	4.74	2000	
	33.28	1029	955	861	795	662	612	581		42.07	675	3.16	1500	
	41.54	1026	952	858	793	660	610	581		33.70	690	2.59	1500	
	51.84	655	605	545	504	419	392	384		27.01	450	1.35	1100	
	3	42.14	951	896	896	896	895	750		609	1400	33.22	895	3.38
51.63		1243	1172	1171	1171	907	737	598	27.12	1079		3.33	2000	
63.25		1239	1168	1168	1168	907	737	598	22.13	1102		2.78	2000	
69.87		944	890	890	890	889	750	609	20.04	890		2.03	1800	
77.48		1236	1166	1166	1165	907	737	598	18.07	1125		2.31	2000	
85.59		1235	1164	1164	1164	907	737	598	16.36	1136		2.12	2000	
104.85		1232	1162	1162	1162	907	737	598	13.35	1161		1.76	2000	
115.83		939	885	885	885	884	750	609	12.09	885		1.22	1800	
130.86		1230	1160	1160	1159	907	737	598	10.70	1159		1.41	2000	
141.90		1229	1159	1159	1159	907	737	598	9.87	1159		1.30	2000	
177.09		1227	1157	1157	1156	907	737	598	7.91	1157		1.04	2000	
221.00		1225	1155	1155	1155	907	737	598	6.33	1155		0.83	2000	
239.64		1009	936	844	780	649	600	581	5.84	829		0.55	1500	
299.08		1007	935	843	779	648	599	581	4.68	849		0.45	1500	
373.25	645	596	537	496	413	385	378	3.75	555	0.24	1100			
4	269.63	1223	1153	1153	1153	907	737	598	1400	5.19	1153	0.70	2000	
	297.86	1223	1153	1153	1153	907	737	598		4.70	1153	0.64	2000	
	330.31	1222	1152	1152	1152	907	737	598		4.24	1152	0.57	2000	
	364.89	1221	1151	1151	1151	907	737	598		3.84	1151	0.52	2000	
	403.08	931	878	878	878	877	750	609		3.47	878	0.36	1800	
	447.00	1220	1150	1150	1150	907	737	598		3.13	1150	0.42	2000	
	493.79	1220	1150	1150	1150	907	737	598		2.84	1150	0.38	2000	
	557.86	1219	1149	1149	1149	907	737	598		2.51	1149	0.34	2000	
	616.26	1218	1149	1149	1148	907	737	598		2.27	1149	0.31	2000	
	754.94	1217	1148	1148	1148	907	737	598		1.85	1148	0.25	2000	
	818.63	1217	1147	1147	1147	907	737	598		1.71	1147	0.23	2000	
	942.17	1217	1147	1147	1147	907	737	598		1.49	1147	0.20	2000	
	1021.64	1216	1147	1147	1146	907	737	598		1.37	1147	0.18	2000	
	1275.01	1215	1146	1146	1146	907	737	598		1.10	1196	0.15	2000	
	1591.22	1215	1145	1145	1145	907	737	598		0.88	1242	0.13	2000	
	1725.44	1001	929	837	774	644	595	577		0.81	1033	0.10	1500	
	2153.35	1001	929	837	773	644	595	577		0.65	1068	0.08	1500	
	2687.39	641	592	533	493	410	383	376		0.52	697	0.04	1100	

5-6

5,6 stadi/stages/stufen
A richiesta / On request / Auf Anfrage

P_{TN}	P	R-L-F-FC-FU FB-FCB	M MX	FS FP
101	18.6	12.6	14.1	11.7
102	12.2	8.7	9.6	8.2
103	8.0	6.0	6.5	5.7
104	6.7	5.2	5.5	4.9

1.2 Prestazioni

1.2 Performances

1.2 Leistungen

EXB		n ₂ X h							10000 Hours Life				T _{max} [Nm]
Stadio Stage Stufe	ir	T _N [Nm]							n ₁ [rpm]	n ₂ [rpm]	T _N [Nm]	P ₁ [kW]	
		10000	20000	50000	100000	500000	1000000	2000000					
2	10.01	981	925	925	924	923	750	609	1400	139.86	679	10.81	1800
	12.26	1279	1205	1205	1205	907	737	598					2000
	14.50	971	915	915	915	914	750	609					1800
	16.59	1043	968	872	806	671	620	581					1500
	17.76	1267	1194	1194	1194	907	737	598					2000
	20.70	664	614	553	511	425	397	389					1100
	24.04	1035	961	865	800	666	615	581					1500
	29.23	1254	1182	1133	1047	871	737	598					2000
	39.56	1026	953	858	793	660	610	581					1500
	49.37	655	606	546	504	420	392	384					1100
3	34.82	953	899	899	899	898	750	609	1400	40.21	898	4.20	1800
	42.65	1246	1175	1175	1175	907	737	598					2000
	52.25	1242	1171	1171	1171	907	737	598					2000
	61.82	1240	1169	1169	1169	907	737	598					2000
	70.71	1238	1167	1167	1167	907	737	598					2000
	75.73	1237	1166	1166	1166	907	737	598					2000
	88.25	1235	1164	1164	1164	907	737	598					2000
	102.48	1233	1162	1162	1162	907	737	598					2000
	127.89	1230	1160	1160	1160	907	737	598					2000
	168.65	1227	1157	1157	1157	907	737	598					2000
	210.48	1225	1155	1155	1155	907	737	598					2000
	228.23	1009	937	844	780	649	600	581					1500
	284.84	1008	936	843	779	648	599	581					1500
	355.47	645	596	537	496	413	386	378					1100
	4	148.43	1229	1158	1158	1158	907	737					598
181.84		1227	1157	1156	1156	907	737	598	2000				
222.76		1225	1155	1155	1155	907	737	598	2000				
246.07		1224	1154	1154	1154	907	737	598	2000				
263.53		1224	1154	1154	1153	907	737	598	2000				
301.45		1223	1153	1153	1152	907	737	598	2000				
322.84		1222	1152	1152	1152	907	737	598	2000				
356.63		1222	1152	1152	1151	907	737	598	2000				
376.21		1221	1151	1151	1151	907	737	598	2000				
407.95		1221	1151	1151	1151	907	737	598	2000				
445.07		1220	1150	1150	1150	907	737	598	2000				
509.12		1219	1150	1150	1149	907	737	598	2000				
545.24		1219	1149	1149	1149	907	737	598	2000				
591.23		1219	1149	1149	1149	907	737	598	2000				
635.38		1218	1149	1148	1148	907	737	598	2000				
737.85		1218	1148	1148	1148	907	737	598	2000				
800.10		1003	931	839	775	645	596	579	1500				
897.30		1217	1147	1147	1147	907	737	598	2000				
972.99		1216	1147	1147	1147	907	737	598	2000				
1214.30		1216	1146	1146	1146	907	737	598	2000				
1515.44		1215	1145	1145	1145	907	737	598	2000				
2050.81		1001	929	837	773	644	595	577	1500				
2559.41		641	592	534	493	410	383	376	1100				

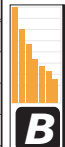

B

P _{TN}	P	R-L-F-FC-FU FB-FCB	M MX	FS FP
102	11,6	9,4	9,9	9,0
103	8,6	7,1	7,5	6,9
104	6,8	5,7	5,9	5,5

1.2 Prestazioni

1.2 Performances

1.2 Leistungen

EX 	Stadio Stage Stufe	ir	n ₂ X h								10000 Hours Life				T _{max} [Nm]	Only Output Version FC																																																																					
			T _N [Nm]								n ₁ [rpm]	n ₂ [rpm]	T _N [Nm]	P ₁ [kW]			T _{max} [Nm]																																																																				
			10000	20000	50000	100000	500000	1000000	2000000																																																																												
1		3.48	1955	1836	1836	1835	1692	1374	1116	1400	402.30	905	39.30	3300	2300																																																																						
		4.26	2415	2228	2228	2228	1661	1349	1096							328.64	944	33.49	3700	2300																																																																	
		5.77	1961	1820	1640	1515	1261	1165	1064												242.63	1004	26.30	2800	2300																																																												
		7.20	1278	1181	1064	983	818	764	749																	194.44	750	15.74	2000	2000																																																							
2		12.11	1902	1793	1793	1793	1692	1374	1116	1400	115.61	1316	16.95	3300	2300																																																																						
		14.84	2415	2228	2228	2144	1661	1349	1096							94.34	1373	14.43	3700	2300																																																																	
		18.17	2415	2228	2228	2134	1661	1349	1096												77.05	1459	12.52	3700	2300																																																												
		20.08	1879	1771	1771	1771	1692	1374	1116																	69.72	1531	11.89	3300	2300																																																							
		24.60	2415	2228	2228	2121	1661	1349	1096																						56.91	1597	10.12	3700	2300																																																		
		30.69	2409	2228	2021	1868	1661	1349	1096																											45.62	1681	8.54	3700	2300																																													
		33.28	1879	1744	1571	1452	1209	1117	1064																																42.07	1233	5.78	2800	2300																																								
		41.54	1873	1739	1566	1447	1205	1113	1064																																					33.70	1260	4.73	2800	2300																																			
		51.84	1227	1134	1022	944	786	734	719																																										27.01	843	2.54	2000	2000																														
3		42.14	1853	1747	1747	1747	1692	1374	1116	1400	33.22	1746	6.60	3300	2300																																																																						
		51.63	2390	2228	2228	2096	1661	1349	1096							27.12	1871	5.78	3700	2300																																																																	
		63.25	2383	2228	2228	2091	1661	1349	1096												22.13	1910	4.81	3700	2300																																																												
		69.87	1841	1736	1735	1735	1692	1374	1116																	20.04	1735	3.96	3300	2300																																																							
		77.48	2378	2228	2228	2086	1661	1349	1096																						18.07	1950	4.01	3700	2300																																																		
		85.59	2375	2228	2228	2084	1661	1349	1096																											16.36	1970	3.67	3700	2300																																													
		104.85	2370	2228	2228	2080	1661	1349	1096																																13.35	2012	3.06	3700	2300																																								
		115.83	1831	1726	1726	1726	1692	1374	1116																																					12.09	1726	2.38	3300	2300																																			
		130.86	2365	2228	2228	2076	1661	1349	1096																																										10.70	2060	2.51	3700	2300																														
		141.90	2364	2228	2228	2074	1661	1349	1096																																															9.87	2078	2.33	3700	2300																									
		177.09	2360	2225	2224	2071	1661	1349	1096																																																				7.91	2127	1.91	3700	2300																				
		221.00	2331	2154	1941	1793	1608	1349	1096																																																									6.33	1889	1.36	3700	2300															
		239.64	1842	1710	1540	1423	1185	1095	1062																																																														5.84	1513	1.01	2800	2300										
		299.08	1840	1708	1538	1422	1183	1094	1061																																																																			4.68	1550	0.83	2800	2300					
		373.25	1208	1116	1006	929	773	722	708																																																																								3.75	1039	0.44	2000	2000
		220.10	2356	2221	2221	2068	1661	1349	1096																																																																												
	243.14	1821	1716	1716	1716	1692	1374	1116	5.76	1716	1.16	3300	2300																																																																								
	269.63	2353	2218	2218	2065	1661	1349	1096						5.19	2218	1.35	3700	2300																																																																			
	297.86	2351	2217	2217	2064	1661	1349	1096											4.70	2217	1.23	3700	2300																																																														
	330.31	2350	2216	2215	2063	1661	1349	1096																4.24	2215	1.10	3700	2300																																																									
	364.89	2349	2214	2214	2062	1661	1349	1096																					3.84	2214	1.00	3700	2300																																																				
	403.08	1815	1712	1711	1711	1692	1374	1116																										3.47	1711	0.70	3300	2300																																															
	447.00	2346	2212	2212	2060	1661	1349	1096																															3.13	2212	0.81	3700	2300																																										
	493.79	2345	2211	2211	2059	1661	1349	1096																																				2.84	2211	0.74	3700	2300																																					
	557.86	2344	2210	2210	2058	1661	1349	1096																																									2.51	2210	0.65	3700	2300																																
	616.26	2343	2209	2209	2057	1661	1349	1096																																														2.27	2209	0.59	3700	2300																											
	754.94	2341	2207	2207	2055	1661	1349	1096																																																			1.85	2207	0.48	3700	2300																						
	818.63	2341	2207	2207	2055	1661	1349	1096																																																								1.71	2207	0.44	3700	2300																	
	942.17	2340	2206	2205	2054	1661	1349	1096																																																													1.49	2206	0.39	3700	2300												
	1021.64	2339	2205	2205	2053	1661	1349	1096																																																																		1.37	2205	0.36	3700	2300							
	1275.01	2337	2204	2203	2052	1661	1349	1096																																																																							1.10	2299	0.30	3700	2300		
	1591.22	2295	2121	1910	1765	1582	1349	1096	0.88	2329	0.24	3700	2300																																																																								
	1725.44	1828	1697	1529	1413	1176	1087	1054						0.81	1887	0.18	2800	2300																																																																			
	2153.35	1827	1696	1528	1412	1175	1086	1054											0.65	1950	0.15	2800	2300																																																														
	2687.39	1201	1110	1000	924	769	718	704																0.52	1306	0.08	2000	2000																																																									

5-6					5,6 stadi/stages/stufen A richiesta / On request / Auf Anfrage	
P _{TN}	P	R-L-F-FC-FU FB-FCB	M MX	FS FP		
201	19.3	13.3	14.8	12.4		
202	12.6	9.2	10.0	8.6		
203	8.2	6.2	6.7	5.9		
204	6.8	5.3	5.7	5.1		

1.2 Prestazioni

1.2 Performances

1.2 Leistungen

Stadio Stage Stufe	ir	n ₂ X h								10000 Hours Life				T _{max} [Nm]	Only Output Version FC																																																																																																													
		T _N [Nm]								n ₁ [rpm]	n ₂ [rpm]	T _N [Nm]	P ₁ [kW]			T _{max} [Nm]																																																																																																												
		10000	20000	50000	100000	500000	1000000	2000000																																																																																																																				
2	10.01	1800	1798	1798	1797	1692	1374	1116	1400	139.86	1242	19.77	3300	2300																																																																																																														
	12.26	2205	2202	2202	2154	1661	1349	1096							114.19	1296	16.84	3700	2300																																																																																																									
	14.50	1604	1604	1604	1603	1462	1351	1116												96.55	1357	14.91	3300	2300																																																																																																				
	16.59	1904	1767	1592	1471	1225	1132	1064																	84.39	1154	11.08	2800	2300																																																																																															
	17.76	1965	1965	1964	1963	1661	1349	1096																						78.83	1449	13.00	3700	2300																																																																																										
	20.70	1245	1150	1036	958	797	744	730																											67.63	770	5.93	2000	2300																																																																																					
	24.04	1889	1754	1580	1460	1215	1123	1064																																58.24	1195	7.92	2800	2300																																																																																
	29.23	1361	1257	1133	1047	871	847	820																																					47.90	876	4.78	3700	2300																																																																											
	39.56	1779	1644	1481	1368	1158	1114	1064																																										35.39	1185	4.77	2800	2300																																																																						
	49.37	1228	1135	1022	945	786	734	720																																															28.36	839	2.71	2000	2000																																																																	
3	34.82	1859	1753	1753	1752	1692	1374	1116	1400	40.21	1751	8.19	3300	2300																																																																																																														
	42.65	2396	2228	2228	2102	1661	1349	1096							32.83	1836	7.01	3700	2300																																																																																																									
	52.25	2389	2228	2228	2096	1661	1349	1096												26.79	1873	5.84	3700	2300																																																																																																				
	61.82	2384	2228	2228	2092	1661	1349	1096																	22.65	1906	5.02	3700	2300																																																																																															
	70.71	2380	2228	2228	2088	1661	1349	1096																						19.80	1932	4.45	3700	2300																																																																																										
	75.73	2378	2228	2228	2087	1661	1349	1096																											18.49	1946	4.19	3700	2300																																																																																					
	88.25	2365	2185	1969	1819	1631	1349	1096																																15.86	1726	3.18	3700	2300																																																																																
	102.48	2371	2228	2228	2080	1661	1349	1096																																					13.66	2008	3.19	3700	2300																																																																											
	124.63	2366	2228	2228	2077	1661	1349	1096																																										11.23	2049	2.68	3700	2300																																																																						
	168.65	2360	2225	2225	2072	1661	1349	1096																																															8.30	2116	2.04	3700	2300																																																																	
	210.48	2333	2156	1942	1794	1609	1349	1096																																																				6.65	1880	1.45	3700	2300																																																												
	228.23	1842	1710	1541	1424	1185	1095	1063																																																									6.13	1505	1.07	2800	2300																																																							
	284.84	1840	1708	1539	1422	1184	1094	1061																																																														4.92	1542	0.88	2800	2300																																																		
	355.47	1208	1116	1006	929	774	722	708																																																																			3.94	1033	0.47	2000	2000																																													
	4	148.43	2363	2228	2227	2074	1661	1349																																																																								1096	1400	9.43	2087	2.34	3700	2300																																						
181.84		2359	2224	2224	2070	1661	1349	1096	7.70	2133	1.95	3700	2300																																																																																																															
222.76		2356	2221	2221	2068	1661	1349	1096						6.28	2180	1.63	3700	2300																																																																																																										
246.07		2354	2219	2219	2066	1661	1349	1096											5.69	2203	1.49	3700	2300																																																																																																					
263.53		2353	2219	2218	2065	1661	1349	1096																5.31	2218	1.40	3700	2300																																																																																																
301.45		2351	2217	2217	2064	1661	1349	1096																					4.64	2217	1.22	3700	2300																																																																																											
322.84		2350	2216	2216	2063	1661	1349	1096																										4.34	2216	1.14	3700	2300																																																																																						
356.63		2349	2215	2215	2062	1661	1349	1096																															3.93	2215	1.04	3700	2300																																																																																	
376.21		2348	2214	2214	2061	1661	1349	1096																																				3.72	2214	0.98	3700	2300																																																																												
407.95		2347	2213	2213	2061	1661	1349	1096																																									3.43	2213	0.90	3700	2300																																																																							
445.07		2346	2212	2212	2060	1661	1349	1096																																														3.15	2212	0.83	3700	2300																																																																		
509.12		2345	2211	2211	2059	1661	1349	1096																																																			2.75	2211	0.72	3700	2300																																																													
545.24		2344	2210	2210	2058	1661	1349	1096																																																								2.57	2210	0.68	3700	2300																																																								
591.23		2344	2209	2209	2057	1661	1349	1096																																																													2.37	2209	0.62	3700	2300																																																			
635.38		2307	2132	1921	1775	1591	1349	1096																																																																		2.20	2109	0.55	3700	2300																																														
737.85		2342	2208	2207	2056	1661	1349	1096																																																																							1.90	2208							0.50	3700	2300																																			
800.10		1832	1701	1532	1416	1178	1089	1057																																																																																		1.75	1727	0.36	2800	2300																														
897.30		2340	2206	2206	2054	1661	1349	1096																																																																																							1.56	2206	0.41	3700	2300																									
972.99		2339	2205	2205	2054	1661	1349	1096																																																																																												1.44	2205	0.38	3700	2300																				
1214.30		2338	2204	2204	2052	1661	1349	1096																																																																																																	1.15	2204	0.30	3700	2300															
1515.44		2295	2121	1911	1766	1583	1349	1096																																																																																																						0.92	2316	0.25	3700	2300										
2050.81		1827	1696	1528	1412	1176	1086	1054																																																																																																											0.68	1936	0.16	2800	2300					
2559.41		1201	1110	1000	924	769	718	704																																																																																																																0.55	1297	0.08	2000	2000



P _{tn}	P	R-L-F-FC-FU FB-FCB	M MX	FS FP
202	11,8	9,6	10,2	9,3
203	8,8	7,3	7,7	7,1
204	6,9	5,8	6,1	5,6



1.2 Prestazioni

1.2 Performances

1.2 Leistungen

EX 	n ₂ X h								10000 Hours Life				T _{max} [Nm] Only Output Version FC				
	Stadio Stage Stufe	ir	T _N [Nm]								n ₁ [rpm]	n ₂ [rpm]		T _N [Nm]	P ₁ [kW]	T _{max} [Nm]	
10000			20000	50000	100000	500000	1000000	2000000	2000000								
1	3.48	2271	2206	2206	2206	2204	1832	1488	1400	402.30	1207	52.42	4000				
	4.26	2926	2699	2699	2604	2168	1799	1461						328.64	1259	44.67	4500
	5.77	2301	2126	1915	1770	1473	1379	1351						242.63	1339	35.07	3300
2	12.11	2171	2171	2171	2170	2167	1769	1437	1400	115.61	1694	21.82	4000				
	14.84	2810	2699	2699	2503	2084	1799	1461						94.34	1830	19.23	4500
	18.17	2796	2699	2697	2492	2074	1799	1461						77.05	1945	16.69	4500
	20.08	2144	2144	2144	2144	2077	1687	1370						69.72	1880	14.60	4000
	24.60	2779	2699	2680	2477	2062	1799	1461						56.91	2031	12.88	4500
	30.69	2428	2244	2021	1868	1674	1603	1461						45.62	1681	8.54	4500
	33.28	2205	2038	1836	1696	1412	1322	1295						42.07	1440	6.75	3300
	41.54	2198	2031	1829	1691	1407	1317	1290						33.70	1472	5.53	3300
	3	42.14	2116	2115	2115	2115	2111	1769						1437	1400	33.22	2113
51.63		2745	2699	2649	2448	2038	1799	1461	27.12	2185	6.74	4500					
63.25		2737	2699	2642	2441	2032	1799	1461	22.13	2230	5.62	4500					
69.87		2101	2101	2101	2100	2097	1769	1437	20.04	2100	4.79	4000					
77.48		2731	2699	2636	2436	2028	1799	1461	18.07	2277	4.68	4500					
85.59		2728	2699	2633	2433	2025	1799	1461	16.36	2300	4.28	4500					
104.85		2722	2699	2628	2428	2021	1799	1461	13.35	2350	3.57	4500					
115.83		2090	2090	2090	2089	2043	1687	1370	12.09	2089	2.87	4000					
130.86		2717	2699	2623	2424	2017	1799	1461	10.70	2405	2.93	4500					
141.90		2715	2699	2621	2422	2016	1799	1461	9.87	2426	2.73	4500					
177.09		2710	2699	2617	2418	2013	1799	1461	7.91	2483	2.24	4500					
221.00		2331	2154	1941	1793	1608	1539	1407	6.33	1889	1.36	4500					
239.64		2161	1997	1799	1663	1384	1295	1269	5.84	1768	1.18	3300					
299.08	2159	1995	1797	1660	1382	1294	1268	4.68	1811	0.96	3300						
4	220.10	2706	2699	2613	2414	2010	1799	1461	1400	6.36	2542	1.90	4500				
	243.14	2078	2078	2078	2077	2074	1769	1437						5.76	2078	1.41	4000
	269.63	2702	2699	2609	2411	2007	1799	1461						5.19	2598	1.59	4500
	297.86	2701	2699	2608	2410	2006	1799	1461						4.70	2626	1.45	4500
	330.31	2699	2699	2606	2408	2005	1799	1461						4.24	2656	1.32	4500
	364.89	2698	2698	2605	2407	2004	1799	1461						3.84	2685	1.21	4500
	403.08	2072	2072	2072	2071	2068	1769	1437						3.47	2072	0.85	4000
	447.00	2695	2695	2602	2405	2002	1799	1461						3.13	2695	0.99	4500
	493.79	2694	2694	2601	2404	2001	1799	1461						2.84	2694	0.90	4500
	557.86	2692	2692	2600	2403	2000	1799	1461						2.51	2692	0.79	4500
	616.26	2691	2691	2599	2402	1999	1799	1461						2.27	2691	0.72	4500
	754.94	2689	2689	2597	2400	1998	1799	1461						1.85	2689	0.59	4500
	818.63	2688	2688	2596	2399	1997	1799	1461						1.71	2688	0.54	4500
	942.17	2687	2687	2595	2398	1996	1799	1461						1.49	2687	0.47	4500
	1021.64	2686	2686	2594	2397	1996	1799	1461						1.37	2686	0.43	4500
	1275.01	2685	2684	2593	2396	1994	1799	1461						1.10	2685	0.35	4500
	1591.22	2295	2121	1910	1765	1582	1515	1385						0.88	2329	0.24	4500
	1725.44	2145	1982	1786	1650	1374	1286	1260						0.81	2180	0.21	3300
	2153.35	2144	1981	1785	1649	1373	1285	1259						0.65	2254	0.17	3300

2300

5-6 5,6 stadi/stages/stufen
A richiesta / On request / Auf Anfrage

P _{EN}	P	R-L-F-FC-FU FB-FCB	M MX	FS FP
251	19.3	13.3	14.8	12.4
252	12.6	9.2	10.0	8.6
253	8.2	6.2	6.7	5.9
254	6.8	5.3	5.7	5.1

1.2 Prestazioni

1.2 Performances

1.2 Leistungen

Stadio Stage Stufe	ir	n ₂ X h							10000 Hours Life				T _{max} [Nm]	Only Output Version FC	
		T _N [Nm]							n ₁ [rpm]	n ₂ [rpm]	T _N [Nm]	P ₁ [kW]			T _{max} [Nm]
		10000	20000	50000	100000	500000	1000000	2000000							
2	10.01	1800	1798	1798	1797	1796	1791	1488	1400	139.86	1657	26.38	4000	2300	
	12.26	2205	2202	2202	2202	2094	1799	1461		114.19	1728	22.46	4500		
	14.50	1604	1604	1604	1603	1462	1351	1313		96.55	1357	14.91	4000		
	16.59	2234	2064	1860	1718	1430	1339	1312		84.39	1348	12.95	3300		
	17.76	1965	1965	1964	1963	1751	1627	1461		78.83	1662	14.91	4500		
	24.04	2217	2049	1846	1706	1420	1329	1302		58.24	1395	9.25	3300		
	29.23	1361	1257	1133	1047	871	847	820		47.90	876	4.78	4500		
	39.56	1779	1644	1481	1368	1158	1133	1085		35.39	1185	4.77	3300		
	3	34.82	2122	2122	2122	2121	2118	1769		1437	1400	40.21	2119		9.91
42.65		2752	2699	2656	2454	2043	1799	1461	32.83	2143		8.19	4500		
52.25		2744	2699	2648	2447	2037	1799	1461	26.79	2187		6.82	4500		
61.82		2738	2699	2643	2442	2033	1799	1461	22.65	2225		5.86	4500		
70.71		2734	2699	2639	2438	2030	1799	1461	19.80	2256		5.20	4500		
75.73		2732	2699	2637	2436	2028	1799	1461	18.49	2272		4.89	4500		
88.25		2365	2185	1969	1819	1631	1562	1428	15.86	1726		3.18	4500		
102.48		2723	2699	2628	2429	2022	1799	1461	13.66	2344		3.73	4500		
124.63		2718	2699	2624	2425	2018	1799	1461	11.23	2393		3.13	4500		
168.65		2711	2699	2617	2419	2013	1799	1461	8.30	2471		2.39	4500		
210.48		2333	2156	1942	1794	1609	1540	1408	6.65	1880		1.45	4500		
228.23		2162	1998	1800	1663	1384	1296	1270	6.13	1758		1.25	3300		
284.84	2159	1995	1797	1661	1383	1294	1268	4.92	1801	1.03	3300				
4	148.43	2714	2699	2620	2421	2015	1799	1461	1400	9.43	2437	2.73	4500		
	181.84	2710	2699	2616	2417	2012	1799	1461		7.70	2490	2.28	4500		
	222.76	2706	2699	2612	2414	2010	1799	1461		6.28	2545	1.90	4500		
	246.07	2704	2699	2611	2413	2008	1799	1461		5.69	2573	1.74	4500		
	263.53	2703	2699	2610	2412	2007	1799	1461		5.31	2592	1.64	4500		
	301.45	2701	2699	2608	2410	2006	1799	1461		4.64	2630	1.45	4500		
	322.84	2699	2699	2607	2409	2005	1799	1461		4.34	2649	1.37	4500		
	356.63	2698	2698	2605	2407	2004	1799	1461		3.93	2678	1.25	4500		
	376.21	2697	2697	2605	2407	2004	1799	1461		3.72	2694	1.19	4500		
	407.95	2696	2696	2604	2406	2003	1799	1461		3.43	2696	1.10	4500		
	445.07	2695	2695	2603	2405	2002	1799	1461		3.15	2695	1.01	4500		
	509.12	2693	2693	2601	2403	2001	1799	1461		2.75	2693	0.88	4500		
	545.24	2693	2692	2600	2403	2000	1799	1461		2.57	2692	0.82	4500		
	591.23	2692	2692	2599	2402	2000	1799	1461		2.37	2691	0.76	4500		
	635.38	2307	2132	1921	1775	1591	1524	1393		2.20	2109	0.55	4500		
	737.85	2689	2689	2597	2400	1998	1799	1461		1.90	2689	0.61	4500		
	800.10	2150	1986	1789	1654	1377	1288	1262		1.75	2017	0.42	3300		
	897.30	2687	2687	2595	2398	1997	1799	1461		1.56	2687	0.50	4500		
	972.99	2687	2687	2595	2398	1996	1799	1461		1.44	2687	0.46	4500		
	1214.30	2685	2685	2593	2396	1995	1799	1461		1.15	2685	0.37	4500		
	1515.44	2295	2121	1911	1766	1583	1516	1386		0.92	2316	0.25	4500		
	2050.81	2144	1981	1785	1649	1373	1285	1259		0.68	2237	0.18	3300		



P _{tn}	P	R-L-F-FC-FU FB-FCB	M MX	FS FP
252	11,8	9,6	10,2	9,3
253	8,8	7,3	7,7	7,1
254	6,9	5,8	6,1	5,6

1.2 Prestazioni

1.2 Performances

1.2 Leistungen

EX 	n ₂ X h								10000 Hours Life				T _{max} [Nm]		
	Stadio Stage Stufe	ir	T _N [Nm]						P ₁ [kW]	T _N [Nm]	P ₁ [kW]				
10000			20000	50000	100000	500000	1000000	2000000				n ₁ [rpm]	n ₂ [rpm]		
1	3.60	3636	3392	3392	3392	2852	2317	1882	1400	388.89	1541	64.69	5900		
	4.25	3394	3123	3123	3123	2811	2283	1855		329.41	1597	56.79	6000		
	5.33	2936	2680	2680	2680	2566	2215	1799		262.66	1658	47.01	5000		
	6.20	2678	2426	2426	2351	1957	1808	1767		225.81	1716	41.83	4100		
	7.50	2214	2046	1843	1703	1418	1330	1302		186.67	1306	26.32	3100		
2	12.53	3412	3392	3392	3392	2231	1812	1472	1400	111.73	1753	21.82	5900		
	14.79	3394	3123	3123	3123	2505	2035	1653		94.66	2069	21.82	6000		
	15.35	3599	3392	3392	3392	2190	1779	1445		91.21	1829	18.58	5900		
	18.12	3394	3123	3123	3123	2460	1998	1623		77.26	2159	18.58	6000		
	20.77	3306	3055	2752	2543	2127	1728	1403		67.40	1945	14.60	5900		
	22.74	2936	2680	2680	2680	2453	2215	1799		61.57	2395	16.43	5000		
	24.52	3394	3123	3123	2946	2389	1941	1576		57.10	2296	14.60	6000		
	30.77	2936	2680	2680	2680	2438	2215	1799		45.50	2464	12.49	5000		
	35.77	2678	2426	2426	2242	1866	1724	1685		39.14	1919	8.37	4100		
	38.40	2936	2680	2465	2278	2072	1962	1799		36.46	2102	8.54	5000		
	44.64	2678	2426	2417	2233	1859	1718	1679		31.36	1961	6.85	4100		
	54.00	2114	1953	1760	1626	1354	1269	1243		25.93	1459	4.21	3100		
	3	43.60	3261	3260	3259	3258	2231	1812		1472	1400	32.11	2548	9.31	5900
		51.47	3394	3123	3123	3123	2505	2035		1653		27.20	3008	9.31	6000
63.05		3394	3123	3123	3123	2505	2035	1653	22.20	3122		7.89	6000		
72.28		3221	3221	3220	3218	2231	1812	1472	19.37	2965		6.54	5900		
77.24		3394	3123	3123	3123	2460	1998	1623	18.13	3122		6.44	6000		
85.33		3394	3123	3123	3123	2505	2035	1653	16.41	3123		5.83	6000		
104.53		3394	3123	3123	3123	2460	1998	1623	13.39	3123		4.76	6000		
110.50		3469	3271	3270	3270	2190	1779	1445	12.67	3270		4.72	5900		
130.45		3394	3123	3123	3123	2460	1998	1623	10.73	3123		3.81	6000		
141.46		3394	3123	3055	2823	2389	1941	1576	9.90	2827		3.19	6000		
163.71		2936	2680	2680	2680	2384	2203	1799	8.55	2680		2.61	5000		
176.54		3394	3123	3045	2814	2389	1941	1576	7.93	2889		2.61	6000		
190.31		2678	2426	2377	2197	1829	1690	1651	7.36	2275		1.91	4100		
221.54		2936	2680	2680	2680	2378	2198	1799	6.32	2680		1.93	5000		
257.54		2678	2426	2372	2192	1825	1686	1647	5.44	2349		1.45	4100		
276.48		2843	2627	2367	2187	1990	1884	1745	5.06	2363		1.36	5000		
321.41		2678	2426	2369	2189	1822	1684	1645	4.36	2406		1.19	4100		
388.80		2076	1918	1728	1597	1329	1247	1221	3.60	1794		0.74	3100		
4		151.72	3178	3177	3176	3175	2231	1812	1472	1400		9.23	3175	3.45	5900
		185.86	3451	3254	3254	3253	2190	1779	1445			7.53	3253	2.88	5900
	219.42	3394	3123	3123	3123	2505	2035	1653	6.38		3123	2.34	6000		
	227.69	3446	3249	3248	3248	2190	1779	1445	6.15		3248	2.35	5900		
	268.80	3394	3123	3123	3123	2505	2035	1653	5.21		3123	1.91	6000		
	296.94	3394	3123	3123	3123	2505	2035	1653	4.71		3123	1.73	6000		
	329.29	3394	3123	3123	3123	2460	1998	1623	4.25		3123	1.56	6000		
	363.76	3394	3123	3123	3123	2505	2035	1653	3.85		3123	1.41	6000		
	416.98	3139	3139	3138	3136	2231	1812	1472	3.36		3139	1.24	5900		
	453.98	3394	3123	3123	3123	2505	2035	1653	3.08		3123	1.13	6000		
	492.27	3394	3123	3123	3123	2505	2035	1653	2.84		3123	1.04	6000		
	556.14	3394	3123	3123	3123	2460	1998	1623	2.52		3123	0.93	6000		
	614.35	3394	3123	3123	3123	2505	2035	1653	2.28		3123	0.84	6000		
	766.71	3394	3123	3123	3123	2505	2035	1653	1.83		3123	0.67	6000		
	795.61	3421	3225	3225	3224	2190	1779	1445	1.76		3225	0.67	5900		
	939.26	3394	3123	3123	3123	2460	1998	1623	1.49		3242	0.57	6000		
	1018.49	3394	3123	2995	2767	2389	1941	1576	1.37		3272	0.53	6000		
	1178.68	2936	2680	2680	2680	2358	2179	1799	1.19		2879	0.40	5000		
	1271.08	3394	3123	2991	2764	2389	1941	1576	1.10		3356	0.43	6000		
	1595.08	2936	2680	2680	2680	2356	2177	1799	0.88		2980	0.31	5000		
	1990.66	2799	2586	2330	2153	1958	1854	1717	0.70		2913	0.24	5000		
	2314.14	2678	2426	2350	2172	1808	1671	1633	0.60		2837	0.20	4100		
	2799.36	2062	1905	1716	1586	1320	1238	1212	0.50		2253	0.13	3100		

5-6 5,6 stadi/stages/stufen
A richiesta / On request / Auf Anfrage

P _{TN}	P	R-L-F-FC-FU FB-FCB	M MX	FS FP	T
301	30.0	19.6	23.2	14.4	28.6
302	20.4	14.5	16.5	11.5	19.6
303	12.8	9.3	10.5	7.6	12.3
304	10.3	7.7	8.6	6.4	9.9

1.2 Prestazioni

1.2 Performances

1.2 Leistungen

Stadio Stage Stufe	ir	$n_2 \times h$							10000 Hours Life				T_{max} [Nm]
		T_N [Nm]							n_1 [rpm]	n_2 [rpm]	T_N [Nm]	P_1 [kW]	
		10000	20000	50000	100000	500000	1000000	2000000					
2	10.35	1862	1860	1860	1859	1857	1853	1843	1400	135.27	1849	28.47	5900
	12.22	2198	2195	2195	2195	2192	2185	1855		114.57	2183	28.47	6000
	15.33	2755	2680	2680	2680	2477	2215	1799		91.32	2276	23.66	5000
	17.83	2678	2426	2426	2275	1894	1750	1710		78.52	1799	16.08	4100
	22.22	2458	2458	2457	2456	2135	2026	1799		63.01	2079	14.91	5000
	25.83	2678	2426	2426	2256	1878	1735	1696		54.20	1861	11.48	4100
	31.25	2133	1971	1775	1641	1366	1281	1254		44.80	1383	7.05	3100
	36.57	1659	1533	1381	1276	1072	1051	1010		38.28	1095	4.77	5000
	42.51	1896	1752	1578	1459	1242	1214	1159		32.93	1273	4.77	4100
51.43	2115	1955	1761	1627	1355	1270	1244	27.22	1452	4.50	3100		
3	36.02	3279	3278	3277	3276	2231	1812	1472	1400	38.87	2406	10.88	5900
	42.52	3394	3123	3123	3123	2505	2035	1653		32.93	2840	10.88	6000
	52.09	3394	3123	3123	3123	2460	1998	1623		26.88	2963	9.27	6000
	61.63	3394	3123	3123	3123	2505	2035	1653		22.72	3122	8.25	6000
	75.49	3394	3123	3123	3123	2460	1998	1623		18.55	3122	6.74	6000
	85.91	3209	3209	2900	2679	2231	1812	1472		16.30	2534	4.81	5900
	94.74	2936	2680	2680	2680	2397	2215	1799		14.78	2680	4.61	5000
	105.24	3471	3273	3272	3207	2190	1779	1445		13.30	3105	4.80	5900
	124.24	3394	3123	3123	3123	2460	1998	1623		11.27	3123	4.09	6000
	142.42	3160	2920	2630	2431	2106	1728	1403		9.83	2435	2.78	5900
	168.13	3394	3123	3047	2816	2389	1941	1576		8.33	2875	2.79	6000
	186.00	2678	2426	2378	2197	1829	1690	1651		7.53	2269	1.99	4100
	210.99	2936	2680	2680	2680	2379	2198	1799		6.64	2680	2.07	5000
	263.31	2845	2629	2368	2188	1991	1885	1746		5.32	2352	1.46	5000
	306.10	2678	2426	2369	2189	1823	1684	1646		4.57	2393	1.27	4100
	370.29	2076	1919	1728	1597	1330	1247	1221		3.78	1784	0.78	3100
	4	147.97	3394	3123	3123	3123	2505	2035		1653	1400	9.46	3123
153.55		3457	3260	3259	3259	2190	1779	1445	9.12	3259		3.54	5900
181.27		3394	3123	3123	3123	2505	2035	1653	7.72	3123		2.87	6000
222.07		3394	3123	3123	3123	2460	1998	1623	6.30	3123		2.34	6000
254.56		3443	3246	3246	3245	2190	1779	1445	5.50	3245		2.12	5900
272.62		3441	3244	3244	3243	2190	1779	1445	5.14	3244		1.98	5900
300.52		3394	3123	3123	3123	2460	1998	1623	4.66	3123		1.73	6000
321.84		3394	3123	3123	3123	2460	1998	1623	4.35	3123		1.62	6000
355.53		3394	3123	3123	3123	2505	2035	1653	3.94	3123		1.46	6000
375.05		3394	3123	3123	3123	2460	1998	1623	3.73	3123		1.39	6000
406.69		3394	3123	3016	2787	2389	1941	1576	3.44	3123		1.28	6000
432.36		3394	3123	3123	3123	2505	2035	1653	3.24	3123		1.20	6000
507.55		3394	3123	3010	2781	2389	1941	1576	2.76	3123		1.03	6000
543.55		3394	3123	3123	3123	2460	1998	1623	2.58	3123		0.96	6000
585.10		3394	3123	3123	3123	2505	2035	1653	2.39	3123		0.89	6000
607.15		3425	3229	3229	3228	2190	1779	1445	2.31	3229		0.89	5900
716.77		3394	3123	3123	3123	2460	1998	1623	1.95	3123		0.72	6000
821.64		3106	2871	2586	2390	2070	1728	1403	1.70	2923		0.59	5900
894.53		3394	3123	3123	3123	2460	1998	1623	1.57	3224		0.60	6000
969.99		3394	3123	2996	2768	2389	1941	1576	1.44	3254		0.56	6000
1045.64		2678	2426	2356	2177	1812	1674	1636	1.34	2590		0.41	4100
1122.55		2936	2680	2680	2680	2359	2179	1799	1.25	2863		0.43	5000
1210.55		3394	3123	2992	2765	2389	1941	1576	1.16	3338		0.46	6000
1339.20		2678	2426	2354	2175	1811	1673	1635	1.05	2664		0.33	4100
1519.12		2936	2680	2680	2680	2356	2177	1799	0.92	2964		0.32	5000
1895.86		2799	2587	2330	2153	1959	1855	1718	0.74	2898		0.26	5000
2203.94		2678	2426	2351	2172	1808	1671	1633	0.64	2821		0.21	4100
2666.06	2062	1905	1716	1586	1320	1238	1213	0.53	2236	0.14	3100		



B

P_{TN}	P	R-L-F-FC-FU FB-FCB	M MX	FS FP	T
302	16,8	13,0	14,3	11,1	16,3
303	12,2	9,6	10,5	8,3	11,9
304	9,4	7,5	8,1	6,5	9,1

1.2 Prestazioni

1.2 Performances

1.2 Leistungen

EX 	n ₂ X h								10000 Hours Life				T _{max} [Nm]
	Stadio Stage Stufe	ir	T _N [Nm]								n ₁ [rpm]	n ₂ [rpm]	
10000			20000	50000	100000	500000	1000000	2000000					
1	3.60	4356	4112	4112	4112	3803	3089	2509	1400	388.89	2055	86.27	7100
	4.25	4113	3786	3786	3785	3705	3044	2473		329.41	2129	75.71	7200
	5.33	3559	3249	3249	3248	2999	2782	2399		262.66	2211	62.69	6000
	6.20	3239	2935	2934	2739	2280	2151	2104		225.81	2091	50.97	4900
2	12.53	3412	3411	3410	3408	2231	1812	1472	1400	111.73	1753	21.82	7100
	14.79	4028	3786	3786	3785	2505	2035	1653		94.66	2069	21.82	7200
	15.35	4114	4112	4112	3549	2190	1779	1445		91.21	1829	18.58	7100
	18.12	4113	3786	3786	3785	2460	1998	1623		77.26	2159	18.58	7200
	20.77	3306	3055	2752	2543	2127	1728	1403		67.40	1945	14.60	7100
	22.74	3559	3249	3249	3248	2867	2342	1902		61.57	2709	18.58	6000
	24.52	3829	3539	3188	2946	2389	1941	1576		57.10	2296	14.60	7200
	30.77	3559	3249	3249	3248	2801	2275	1848		45.50	2880	14.60	6000
	35.77	3239	2935	2827	2612	2175	2052	2006		39.14	2236	9.75	4900
	38.40	2961	2736	2465	2278	2072	1962	1817		36.46	2102	8.54	6000
	44.64	3239	2935	2816	2603	2166	2044	1999		31.36	2285	7.98	4900
	3	43.60	3261	3260	3259	3258	2231	1812		1472	1400	32.11	2548
51.47		3849	3786	3786	3785	2505	2035	1653	27.20	3008		9.31	7200
63.05		3829	3786	3786	3785	2505	2035	1653	22.20	3196		8.08	7200
72.28		3221	3221	3220	3218	2231	1812	1472	19.37	2965		6.54	7100
77.24		4113	3786	3786	3785	2460	1998	1623	18.13	3335		6.88	7200
85.33		3802	3786	3786	3785	2505	2035	1653	16.41	3500		6.54	7200
96.87		3559	3249	3249	3248	2801	2342	1902	14.45	3227		5.31	6000
104.53		4113	3786	3786	3785	2460	1998	1623	13.39	3652		5.57	7200
130.45		4113	3786	3786	3785	2460	1998	1623	10.73	3785		4.62	7200
141.46		3670	3391	3055	2823	2389	1941	1576	9.90	2827		3.19	7200
163.60		3559	3249	3249	3248	2787	2342	1902	8.56	3248		3.16	6000
177.40		3559	3249	3249	3248	2785	2275	1848	7.89	3248		2.92	6000
190.31		3239	2935	2770	2560	2131	2010	1966	7.36	2651		2.22	4900
221.40		3559	3249	3249	3248	2780	2275	1848	6.32	3249		2.34	6000
257.54		3239	2935	2764	2554	2126	2006	1962	5.44	2738		1.70	4900
276.31		2843	2627	2367	2187	1990	1884	1745	5.07	2363		1.36	6000
321.41	3239	2935	2704	2499	2123	2003	1959	4.36	2747	1.36	4900		
4	151.72	3178	3177	3176	3175	2231	1812	1472	1400	9.23	3175	3.45	7100
	185.86	3945	3945	3944	3549	2190	1779	1445		7.53	3827	3.39	7100
	219.42	4113	3786	3786	3785	2460	1998	1623		6.38	3785	2.84	7200
	227.69	3938	3938	3938	3549	2190	1779	1445		6.15	3906	2.83	7100
	268.80	4113	3786	3786	3785	2460	1998	1623		5.21	3786	2.32	7200
	296.94	3726	3725	3724	3722	2505	2035	1653		4.71	3724	2.06	7200
	329.29	4113	3786	3786	3785	2460	1998	1623		4.25	3786	1.89	7200
	363.76	4113	3786	3786	3785	2460	1998	1623		3.85	3786	1.71	7200
	413.23	3559	3249	3249	3248	2769	2342	1902		3.39	3249	1.30	6000
	453.98	4113	3786	3786	3785	2460	1998	1623		3.08	3786	1.37	7200
	492.27	3706	3706	3704	3702	2505	2035	1653		2.84	3705	1.24	7200
	556.14	4113	3786	3786	3785	2460	1998	1623		2.52	3786	1.12	7200
	603.05	4113	3786	3786	3785	2460	1998	1623		2.32	3786	1.03	7200
	752.61	4113	3786	3786	3785	2460	1998	1623		1.86	3786	0.83	7200
	795.61	3910	3910	3909	3549	2190	1779	1445		1.76	3910	0.81	7100
	939.26	4113	3786	3786	3785	2460	1998	1623		1.49	3930	0.69	7200
	1018.49	3598	3324	2995	2767	2389	1941	1576		1.37	3469	0.56	7200
	1178.68	3559	3249	3249	3248	2757	2342	1902		1.19	3489	0.49	6000
	1271.08	3593	3320	2991	2764	2389	1941	1576		1.10	3554	0.46	7200
	1595.08	3559	3249	3249	3248	2754	2275	1848		0.88	3612	0.37	6000
1854.28	3239	2935	2740	2532	2108	1989	1945	0.76	3345	0.30	4900		
2314.14	3198	2935	2662	2460	2107	1988	1944	0.60	3386	0.24	4900		

5-6

5,6 stadi/stages/stufen
A richiesta / On request / Auf Anfrage

P _{TN}	P	R-L-F-FC-FU FB-FCB	M MX	FS FP	T
351	30.0	19.6	23.2	14.4	28.6
352	20.4	14.5	16.5	11.5	19.6
353	12.8	9.3	10.5	7.6	12.3
354	10.3	7.7	8.6	6.4	9.9

1.2 Prestazioni

1.2 Performances

1.2 Leistungen

Stadio Stage Stufe	ir	n ₂ X h							10000 Hours Life				T _{max} [Nm]
		T _N [Nm]							n ₁ [rpm]	n ₂ [rpm]	T _N [Nm]	P ₁ [kW]	
		10000	20000	50000	100000	500000	1000000	2000000					
2	10.35	1862	1860	1860	1859	1857	1853	1843	1400	135.27	1849	28.47	7100
	12.22	2198	2195	2195	2195	2192	2185	2172		114.57	2183	28.47	7200
	15.33	2755	2755	2755	2755	2748	2685	2399		91.32	2703	28.09	6000
	17.83	3203	2935	2868	2651	2207	2082	2036		78.52	2096	18.73	4900
	22.22	2458	2458	2457	2456	2135	2026	1978		63.01	2079	14.91	6000
	25.83	2858	2857	2845	2629	2188	2065	2019		54.20	2168	13.37	4900
	29.14	1357	1254	1130	1044	869	844	818		48.04	873	4.77	7200
	36.57	1659	1533	1381	1276	1072	1051	1010		38.28	1095	4.77	6000
3	42.51	1896	1752	1578	1459	1242	1214	1159	32.93	1273	4.77	4900	
	36.02	3279	3278	3277	3276	2231	1812	1472	1400	38.87	2406	10.88	7100
	42.52	3871	3786	3786	3785	2505	2035	1653		32.93	2840	10.88	7200
	52.09	4113	3786	3786	3785	2460	1998	1623		26.88	2963	9.27	7200
	61.63	3831	3786	3786	3785	2505	2035	1653		22.72	3175	8.39	7200
	75.49	4113	3786	3786	3785	2460	1998	1623		18.55	3312	7.15	7200
	88.46	3559	3249	3249	3248	2801	2275	1848		15.83	3197	5.89	6000
	94.74	3559	3249	3249	3248	2802	2342	1902		14.78	3219	5.54	6000
	105.24	3968	3853	3471	3207	2190	1779	1445		13.30	3105	4.80	7100
	124.24	4113	3786	3786	3716	2460	1998	1623		11.27	3665	4.81	7200
	155.91	3559	3249	3249	3248	2788	2342	1902		8.98	3248	3.39	6000
	168.13	3661	3383	3047	2816	2389	1941	1576		8.33	2875	2.79	7200
	186.00	3239	2935	2726	2519	2131	2011	1966		7.53	2602	2.28	4900
	210.99	3559	3249	3249	3248	2781	2275	1848		6.64	3248	2.51	6000
	245.27	3239	2935	2765	2555	2127	2007	1962		5.71	2723	1.81	4900
	306.10	3239	2935	2706	2501	2124	2004	1959		4.57	2734	1.45	4900
4	153.55	3952	3952	3951	3549	2190	1779	1445		1400	9.12	3649	3.96
	181.27	4113	3786	3786	3785	2460	1998	1623	7.72		3785	3.48	7200
	222.07	4113	3786	3786	3785	2460	1998	1623	6.30		3785	2.84	7200
	254.56	3935	3935	3934	3549	2190	1779	1445	5.50		3934	2.57	7100
	272.62	3933	3933	3933	3549	2190	1779	1445	5.14		3933	2.41	7100
	300.52	4113	3786	3786	3785	2460	1998	1623	4.66		3786	2.10	7200
	321.84	4113	3786	3786	3785	2460	1998	1623	4.35		3786	1.96	7200
	355.53	3718	3718	3716	3714	2505	2035	1653	3.94		3717	1.74	7200
	375.05	4113	3786	3786	3785	2460	1998	1623	3.73		3786	1.68	7200
	406.69	3623	3348	3016	2787	2389	1941	1576	3.44		3147	1.29	7200
	432.36	4113	3786	3786	3785	2460	1998	1623	3.24		3786	1.46	7200
	507.55	3616	3341	3010	2781	2389	1941	1576	2.76		3221	1.06	7200
	543.55	4113	3786	3786	3785	2460	1998	1623	2.58		3786	1.16	7200
	585.10	3700	3700	3699	3696	2505	2035	1653	2.39		3700	1.05	7200
	607.15	3915	3914	3914	3549	2190	1779	1445	2.31		3914	1.08	7100
	716.77	4113	3786	3786	3785	2460	1998	1623	1.95		3786	0.88	7200
	821.64	3106	2871	2586	2390	2070	1728	1403	1.70		2923	0.59	7100
	894.53	4113	3786	3786	3785	2460	1998	1623	1.57		3908	0.73	7200
	969.99	3599	3325	2996	2768	2389	1941	1576	1.44		3451	0.59	7200
	1045.64	3239	2935	2745	2537	2112	1992	1948	1.34		3133	0.50	4900
	1122.55	3559	3249	3249	3248	2757	2342	1902	1.25		3470	0.52	6000
	1210.55	3594	3321	2992	2765	2389	1941	1576	1.16		3535	0.49	7200
	1339.20	3207	2935	2670	2467	2110	1991	1947	1.05		3191	0.40	4900
	1519.12	3559	3249	3249	3248	2755	2275	1848	0.92		3592	0.39	6000
	1895.86	2799	2587	2330	2153	1959	1855	1718	0.74		2898	0.26	6000
	2203.94	3199	2935	2663	2461	2107	1988	1944	0.64		3368	0.26	4900



P _{tn}	P	R-L-F-FC-FU FB-FCB	M MX	FS FP	T
352	16,8	13,0	14,3	11,1	16,3
353	12,2	9,6	10,5	8,3	11,9
354	9,4	7,5	8,1	6,5	9,1



1.2 Prestazioni

1.2 Performances

1.2 Leistungen

EX 	n ₂ X h								10000 Hours Life				T _{max} [Nm]		
	Stadio Stage Stufe	ir	T _N [Nm]								n ₁ [rpm]	n ₂ [rpm]		T _N [Nm]	P ₁ [kW]
10000			20000	50000	100000	500000	1000000	2000000	10000	20000			50000		
2	12.53	3412	3411	3410	3408	2231	1812	1472	1400	111.73	1753	21.82	10000	9000	
	14.79	4028	4027	4026	4023	2505	2035	1653		94.66	2069	21.82	11000	9000	
	15.35	4433	4433	4266	3549	2190	1779	1445		91.21	1829	18.58	10000	9000	
	18.12	5233	5233	4908	3986	2460	1998	1623		77.26	2159	18.58	11000	9000	
	21.58	5104	4623	4623	4328	3264	2651	2153		64.87	3018	21.81	8050	8050	
	22.74	5687	5192	5192	4673	2883	2342	1902		61.57	2709	18.58	9500	9000	
	26.43	5104	4623	4623	4310	3204	2602	2114		52.97	3149	18.58	8050	8050	
	30.77	4683	4327	3898	3602	2801	2275	1848		45.50	2881	14.60	9500	9000	
	35.77	5104	4623	4455	4116	3112	2528	2053		39.14	3349	14.60	8050	8050	
	38.40	2961	2736	2465	2278	2072	1962	1817		36.46	2102	8.54	9500	9000	
3	43.27	3889	3594	3237	2992	2490	2336	2287	32.35	2617	9.43	6000	6000		
	54.00	3876	3582	3227	2982	2482	2328	2280	25.93	2675	7.73	6000	6000		
	43.60	3261	3260	3259	3258	2231	1812	1472	1400	32.11	2548	9.31	10000	9000	
	51.47	3849	3849	3848	3845	2505	2035	1653		27.20	3008	9.31	11000	9000	
	64.59	4831	4830	4828	4760	2937	2386	1938		21.68	3774	9.31	9500	9000	
	75.08	5104	4623	4586	4238	3264	2651	2153		18.65	3947	8.38	8050	8050	
	79.12	5687	5192	5192	4673	2883	2342	1902		17.69	3938	7.93	9500	9000	
	85.33	3802	3802	3800	3798	2505	2035	1653		16.41	3500	6.54	11000	9000	
	96.93	5687	5192	5192	4673	2883	2342	1902		14.44	4185	6.88	9500	9000	
	104.53	4965	4964	4700	3986	2460	1998	1623		13.39	3652	5.57	11000	9000	
107.08	4771	4771	4768	4760	2937	2386	1938	13.07		4392	6.53	9500	9000		
131.17	5687	5192	5192	4673	2883	2342	1902	10.67		4583	5.57	9500	9000		
4	163.71	5687	5192	5192	4673	2883	2342	1902	8.55	4898	4.77	9500	9000		
	177.51	4488	4147	3736	3452	2801	2275	1848	7.89	3547	3.19	9500	9000		
	190.31	5104	4623	4544	4199	3204	2602	2114	7.36	4348	3.64	8050	8050		
	221.54	4473	4134	3724	3441	2801	2275	1848	6.32	3626	2.61	9500	9000		
	257.54	5104	4623	4255	3932	3112	2528	2053	5.44	4215	2.61	8050	8050		
	276.48	2843	2627	2367	2187	1990	1884	1745	5.06	2363	1.36	9500	9000		
	311.54	3811	3522	3173	2932	2440	2289	2241	4.49	3211	1.64	6000	6000		
	388.80	3806	3517	3169	2928	2437	2286	2239	3.60	3289	1.35	6000	6000		
	219.42	4904	4904	4645	3986	2460	1998	1623	1400	6.38	4518	3.39	11000	9000	
	224.77	4707	4707	4704	4701	2937	2386	1938		6.23	4704	3.45	9500	9000	
275.35	5687	5192	5192	4673	2883	2342	1902	5.08		5192	3.10	9500	9000		
308.13	4129	4128	3986	3549	2190	1779	1445	4.54		4030	2.15	10000	9000		
337.32	5687	5192	5192	4673	2883	2342	1902	4.15		5192	2.54	9500	9000		
363.76	4874	4874	4618	3986	2460	1998	1623	3.85		4757	2.15	11000	9000		
413.23	5687	5192	5192	4673	2883	2342	1902	3.39		5192	2.07	9500	9000		
456.49	5687	5192	5192	4673	2883	2342	1902	3.07		5192	1.88	9500	9000		
510.82	4109	4108	3968	3549	2190	1779	1445	2.74		4108	1.32	10000	9000		
569.69	5687	5192	5192	4673	2883	2342	1902	2.46		5192	1.50	9500	9000		
603.05	4851	4850	4596	3986	2460	1998	1623	2.32	4850	1.32	11000	9000			
756.77	5687	5192	5192	4673	2883	2342	1902	1.85	5301	1.15	9500	9000			
811.31	5104	4623	4507	4165	3204	2602	2114	1.73	4795	0.98	8050	8050			
944.45	5687	5192	5192	4673	2883	2342	1902	1.48	5437	0.95	9500	9000			
1024.12	4405	4071	3667	3389	2801	2275	1848	1.37	4251	0.69	9500	9000			
1178.68	5687	5192	5192	4673	2883	2342	1902	1.19	5577	0.78	9500	9000			
1278.11	4399	4065	3662	3384	2801	2275	1848	1.10	4354	0.56	9500	9000			
1595.08	4394	4060	3658	3380	2801	2275	1848	0.88	4460	0.46	9500	9000			
1854.28	5021	4623	4180	3862	3112	2528	2053	0.76	5184	0.46	8050	8050			
2243.08	3782	3495	3148	2909	2422	2271	2224	0.62	3997	0.29	6000	6000			
2799.36	3780	3493	3147	2908	2421	2270	2223	0.50	4096	0.24	6000	6000			

5-6 5,6 stadi/stages/stufen
A richiesta / On request / Auf Anfrage

P _{tn}	P	R-L-F-FC-FU FB-FCB	M MX	FS FP	T
402	21.2	15.2	17.3	12.2	20.3
403	13.3	9.8	11.0	8.0	12.8
404	10.6	8.0	8.9	6.7	10.2

1.2 Prestazioni

1.2 Performances

1.2 Leistungen

Stadio Stage Stufe	EXB 	n ₂ X h								10000 Hours Life				T _{max} [Nm]	Only Output Version FC		
		T _N [Nm]								n ₁ [rpm]	n ₂ [rpm]	T _N [Nm]	P ₁ [kW]			T _{max} [Nm]	
		10000	20000	50000	100000	500000	1000000	2000000	8000000								
3	36.02	3279	3278	3277	3276	2231	1812	1472	1400	38.87	2406	10.88	10000	9000			
	42.52	3871	3870	3869	3866	2505	2035	1653					32.93	2840	10.88	11000	9000
	52.09	5046	5045	4773	3986	2460	1998	1623					26.88	2963	9.27	11000	9000
	65.37	5687	5192	5192	4673	2883	2342	1902					21.42	3719	9.27	9500	9000
	75.49	4999	4999	4731	3986	2460	1998	1623					18.55	3312	7.15	11000	9000
	88.46	4547	4201	3785	3498	2801	2275	1848					15.83	3319	6.11	9500	9000
	94.74	5687	5192	5192	4673	2883	2342	1902					14.78	4156	7.15	9500	9000
	110.13	5104	4623	4566	4219	3204	2602	2114					12.71	4106	6.07	8050	8050
	124.24	4830	4464	4021	3716	2460	1998	1623					11.27	3665	4.81	11000	9000
	155.91	5687	5192	4917	4544	2883	2342	1902					8.98	4600	4.81	9500	9000
	181.25	5104	4623	4545	4200	3204	2602	2114					7.72	4326	3.89	8050	8050
	210.99	4476	4136	3726	3443	2801	2275	1848					6.64	3608	2.79	9500	9000
	245.27	5104	4623	4258	3935	3112	2528	2053					5.71	4194	2.79	8050	8050
	296.70	3812	3523	3174	2933	2441	2290	2242					4.72	3195	1.75	6000	6000
	370.29	3807	3518	3169	2929	2438	2287	2239					3.78	3272	1.44	6000	6000
4	181.27	4918	4917	4657	3986	2460	1998	1623	1400	7.72	4308	3.96	11000	9000			
	227.48	5687	5192	5192	4673	2883	2342	1902					6.15	5191	3.80	9500	9000
	262.72	4893	4892	4634	3986	2460	1998	1623					5.33	4601	2.92	11000	9000
	278.68	5687	5192	5192	4673	2883	2342	1902					5.02	5192	3.10	9500	9000
	300.52	4885	4884	4627	3986	2460	1998	1623					4.66	4665	2.59	11000	9000
	321.84	4881	4880	4624	3986	2460	1998	1623					4.35	4698	2.43	11000	9000
	357.87	5104	4623	4524	4181	3264	2651	2153					3.91	4623	2.15	8050	8050
	375.05	4873	4872	4616	3986	2460	1998	1623					3.73	4772	2.12	11000	9000
	403.88	5687	5192	5192	4673	2883	2342	1902					3.47	5192	2.14	9500	9000
	435.54	4865	4864	4609	3986	2460	1998	1623					3.21	4847	1.85	11000	9000
	470.65	5687	5192	5192	4673	2883	2342	1902					2.97	5192	1.83	9500	9000
	529.66	4856	4856	4601	3986	2460	1998	1623					2.64	4855	1.53	11000	9000
	542.57	5687	5192	5192	4673	2883	2342	1902					2.58	5192	1.59	9500	9000
	593.29	5062	4623	4214	3894	3112	2528	2053					2.36	4591	1.29	8050	8050
	664.67	5687	5192	5192	4673	2883	2342	1902					2.11	5192	1.30	9500	8050
	716.77	4844	4843	4590	3986	2460	1998	1623					1.95	4843	1.12	11000	9000
	859.84	5046	4623	4201	3882	3112	2528	2053					1.63	4773	0.93	8050	8050
	899.48	5687	5192	5192	4673	2883	2342	1902					1.56	5407	1.00	9500	9000
	923.08	4409	4074	3670	3391	2801	2275	1848					1.52	4204	0.76	9500	9000
	1045.64	5104	4623	4503	4161	3204	2602	2114					1.34	4936	0.79	8050	8050
	1122.55	5687	5192	5192	4673	2883	2342	1902					1.25	5545	0.82	9500	9000
	1217.24	4401	4066	3663	3385	2801	2275	1848					1.15	4331	0.59	9500	9000
	1304.96	5104	4623	4500	4158	3204	2602	2114					1.07	5063	0.64	8050	8050
	1519.12	4395	4061	3659	3381	2801	2275	1848					0.92	4436	0.49	9500	9000
	1765.98	5022	4623	4181	3863	3112	2528	2053					0.79	5157	0.48	8050	8050
2136.26	3783	3495	3149	2910	2422	2272	2225	0.66	3968	0.31	6000	6000					
2666.06	3781	3494	3147	2908	2421	2271	2224	0.53	4075	0.26	6000	6000					



P _{tn}	P	R-L-F-FC-FU FB-FCB	M MX	FS FP	T
403	12,6	10,0	10,9	8,7	12,2
404	9,6	7,7	8,4	6,8	9,4

1.2 Prestazioni

1.2 Performances

1.2 Leistungen

EX 	n ₂ X h								10000 Hours Life				T _{max} [Nm]	Only Output Version FC
	Stadio Stage Stufe	ir	T _N [Nm]						P ₁ [kW]	T _{max} [Nm]				
10000			20000	50000	100000	500000	1000000	2000000			n ₁ [rpm]	n ₂ [rpm]	T _N [Nm]	P ₁ [kW]
1	3.60	7103	6626	6626	6625	5007	4067	3303	1400	388.89	2706	113.60	10000	9000
	4.25	6730	6194	6194	6193	4935	4008	3256		329.41	2803	99.67	11000	9000
	5.33	5687	5192	5192	5191	4788	3889	3159		262.66	2911	82.54	9500	9000
	6.20	5104	4623	4623	4493	3740	3456	3125		225.81	3013	73.45	8050	8050
	7.50	4060	3751	3380	3123	2600	2438	2388		186.67	2394	48.24	6000	6000
2	12.53	6509	6509	6507	6505	4085	3318	2695	1400	111.73	3209	39.94	10000	9000
	14.79	6730	6194	6194	6193	4588	3727	3027		94.66	3788	39.94	11000	9000
	15.35	7081	6626	6626	6499	4010	3257	2646		91.21	3348	34.02	10000	9000
	18.12	6730	6194	6194	6193	4504	3658	2972		77.26	3953	34.02	11000	9000
	20.77	6036	5577	5024	4643	3895	3164	2570		67.40	3561	26.74	10000	9000
	22.74	5687	5192	5192	5191	4755	3889	3159		61.57	4498	30.85	9500	9000
	24.52	6730	6194	5820	5378	4375	3554	2886		57.10	4204	26.74	11000	9000
	30.77	5687	5192	5192	5191	4725	3889	3159		45.50	4776	24.21	9500	9000
	35.77	5104	4623	4623	4285	3567	3296	3125		39.14	3668	15.99	8050	8050
	38.40	5548	5127	4618	4268	3882	3676	3159		36.46	3939	16.00	9500	9000
	44.64	5104	4623	4620	4269	3554	3284	3125		31.36	3748	13.09	8050	8050
	54.00	3876	3582	3227	2982	2482	2328	2280		25.93	2675	7.73	6000	6000
	3	43.60	6358	6357	6355	6352	4085	3318		2695	1400	32.11	4665	17.05
51.47		6730	6194	6194	6193	4588	3727	3027	27.20	5507		17.05	11000	9000
63.05		6730	6194	6194	6193	4588	3727	3027	22.20	5853		14.79	11000	9000
72.28		6280	6280	6278	6274	4085	3318	2695	19.37	5429		11.97	10000	9000
77.24		6730	6194	6194	6193	4504	3658	2972	18.13	6107		12.60	11000	9000
85.33		6730	6194	6194	6193	4588	3727	3027	16.41	6193		11.57	11000	9000
96.93		5687	5192	5192	5191	4645	3889	3159	14.44	5191		8.53	9500	9000
104.53		6730	6194	6194	6193	4504	3658	2972	13.39	6193		9.44	11000	9000
110.50		6825	6435	6194	6008	4010	3257	2646	12.67	5959		8.59	10000	9000
130.45		6730	6194	6194	6193	4504	3658	2972	10.73	6193		7.56	11000	9000
141.46		6701	6192	5578	5155	4375	3554	2886	9.90	5161		5.82	11000	9000
163.71		5687	5192	5192	5191	4621	3889	3159	8.55	5191		5.05	9500	9000
176.54		6679	6172	5560	5138	4375	3554	2886	7.93	5275		4.76	11000	9000
190.31		5104	4623	4544	4199	3495	3230	3125	7.36	4348		3.64	8050	8050
221.54		5687	5192	5192	5191	4610	3889	3159	6.32	5191		3.73	9500	9000
257.54		5104	4623	4534	4189	3487	3223	3125	5.44	4491		2.78	8050	8050
276.48		5327	4922	4434	4098	3728	3530	3159	5.06	4428		2.55	9500	9000
321.41		5104	4623	4527	4183	3483	3218	3125	4.36	4599		2.28	8050	8050
388.80		3806	3517	3169	2928	2437	2286	2239	3.60	3289		1.35	6000	6000
4		151.72	6196	6195	6193	6190	4085	3318	2695	1400		9.23	6191	6.72
	185.86	6790	6402	6401	6400	4010	3257	2646	7.53		6401	5.67	10000	9000
	219.42	6730	6194	6194	6193	4588	3727	3027	6.38		6194	4.65	11000	9000
	227.69	6779	6391	6390	6390	4010	3257	2646	6.15		6390	4.62	10000	9000
	268.80	6730	6194	6194	6193	4588	3727	3027	5.21		6194	3.80	11000	9000
	296.94	6730	6194	6194	6193	4588	3727	3027	4.71		6194	3.43	11000	9000
	329.29	6730	6194	6194	6193	4504	3658	2972	4.25		6194	3.10	11000	9000
	363.76	6730	6194	6194	6193	4588	3727	3027	3.85		6194	2.81	11000	9000
	416.98	6121	6121	6119	6115	4085	3318	2695	3.36		6120	2.42	10000	9000
	453.98	6730	6194	6194	6193	4588	3727	3027	3.08		6194	2.24	11000	9000
	492.27	6730	6194	6194	6193	4588	3727	3027	2.84		6194	2.07	11000	9000
	556.14	6730	6194	6194	6193	4504	3658	2972	2.52		6194	1.84	11000	9000
	614.35	6730	6194	6194	6193	4588	3727	3027	2.28		6194	1.66	11000	9000
	766.71	6730	6194	5755	5566	4588	3727	3027	1.83		6194	1.33	11000	9000
	795.61	6730	6345	5947	5769	4010	3257	2646	1.76		6345	1.31	10000	9000
	939.26	6730	6194	6194	6193	4504	3658	2972	1.49		6430	1.13	11000	9000
	1018.49	6569	6070	5468	5053	4375	3554	2886	1.37		6335	1.02	11000	9000
	1178.68	5687	5192	5192	5191	4571	3889	3159	1.19		5577	0.78	9500	9000
	1271.08	6560	6062	5461	5046	4375	3554	2886	1.10		6489	0.84	11000	9000
	1595.08	5687	5192	5192	5191	4567	3889	3159	0.88		5773	0.60	9500	9000
	1990.66	5244	4845	4365	4034	3669	3474	3159	0.70		5458	0.45	9500	9000
	2314.14	5104	4623	4493	4152	3456	3194	3121	0.60		5406	0.38	8050	8050
	2799.36	3780	3493	3147	2908	2421	2270	2223	0.50		4131	0.24	6000	6000

5-6 5,6 stadi/stages/stufen
A richiesta / On request / Auf Anfrage

P _{EN}	P	R-L-F-FC-FU FB-FCB	M MX	FS FP	T
501	31.4	21.0	24.6	15.8	29.9
502	21.6	15.7	17.7	12.7	20.8
503	13.5	10.0	11.2	8.3	13.0
504	10.8	8.2	9.1	6.9	10.4

1.2 Prestazioni

1.2 Performances

1.2 Leistungen

EXB 	n ₂ X h								10000 Hours Life				T _{max} [Nm]	Only Output Version FC
	Stadio Stage Stufe	ir	T _N [Nm]						n ₁ [rpm]	n ₂ [rpm]	T _N [Nm]	P ₁ [kW]		
10000			20000	50000	100000	500000	1000000	2000000						
2	9.11	4708	4708	4707	4706	4698	4067	3303	1400	153.68	3575	62.53	10000	9000
	10.75	5558	5558	5557	5555	4935	4008	3256		130.23	3703	54.89	11000	9000
	13.49	5687	5192	5192	5191	4788	3889	3159		103.78	3846	45.43	9500	9000
	15.68	5104	4623	4623	4362	3631	3355	3125		89.29	3399	34.54	8050	8050
	17.71	4864	4824	4824	4824	4320	4008	3256		79.05	4100	36.89	11000	9000
	22.22	5687	5192	5192	5191	4757	3889	3159		63.01	4467	32.04	9500	9000
	25.83	5104	4623	4623	4312	3589	3317	3125		54.20	3556	21.94	8050	8050
	29.28	4328	3999	3602	3329	2771	2694	2610		47.81	2785	15.15	11000	9000
	36.74	5292	4890	4405	4071	3420	3353	3159		38.11	3495	15.16	9500	9000
	42.71	5104	4623	4623	4272	3556	3286	3125		32.78	3732	13.92	8050	8050
	51.67	3878	3584	3229	2983	2484	2329	2281		27.10	2663	8.21	6000	6000
	36.02	6375	6374	6373	6371	4085	3318	2695		38.87	4405	19.92	10000	9000
42.52	6730	6194	6194	6193	4588	3727	3027	32.93	5201	19.93	11000	9000		
52.09	6730	6194	6194	6193	4504	3658	2972	26.88	5426	16.97	11000	9000		
61.63	6713	6194	6194	6193	4588	3727	3027	22.72	5680	15.01	11000	9000		
75.49	6730	6194	6194	6193	4504	3658	2972	18.55	6065	13.09	11000	9000		
86.54	5817	5375	4842	4475	3876	3164	2570	16.18	4236	7.97	10000	9000		
94.74	5687	5192	5192	5191	4646	3889	3159	14.78	5191	8.93	9500	9000		
102.16	6730	6194	5609	5183	4375	3554	2886	13.70	5001	7.97	11000	9000		
110.40	5404	4994	4499	4157	3782	3581	3159	12.68	4046	5.97	9500	9000		
128.21	5687	5192	5192	5191	4632	3889	3159	10.92	5191	6.60	9500	9000		
168.13	6315	5836	5257	4862	4375	3554	2886	8.33	4960	4.81	11000	9000		
186.00	5104	4623	4545	4199	3496	3230	3125	7.53	4338	3.80	8050	8050		
210.99	5687	5192	5192	5191	4612	3889	3159	6.64	5191	4.01	9500	9000		
263.31	5330	4925	4437	4100	3730	3532	3159	5.32	4406	2.73	9500	9000		
306.10	5104	4623	4529	4185	3484	3219	3125	4.57	4575	2.43	8050	8050		
370.29	3807	3518	3169	2929	2438	2287	2239	3.78	3272	1.44	6000	6000		
3	125.34	6215	6214	6212	6209	4085	3318	2695	1400	11.17	6208	8.25	10000	9000
	153.55	6195	6194	6192	6189	4085	3318	2695		9.12	6189	6.72	10000	9000
	181.27	6730	6194	6194	6193	4588	3727	3027		7.72	6194	5.69	11000	9000
	222.07	6730	6194	6194	6193	4504	3658	2972		6.30	6194	4.64	11000	9000
	245.31	6730	6194	6194	6193	4588	3727	3027		5.71	6194	4.21	11000	9000
	272.62	6770	6382	6382	6381	4010	3257	2646		5.14	6382	3.90	10000	9000
	306.15	6730	6194	5839	5646	4588	3727	3027		4.57	5898	3.21	11000	9000
	321.84	6730	6194	6194	6193	4504	3658	2972		4.35	6194	3.21	11000	9000
	355.53	6730	6194	6194	6193	4588	3727	3027		3.94	6194	2.90	11000	9000
	375.05	6730	6194	6194	6193	4504	3658	2972		3.73	6194	2.75	11000	9000
	406.69	6615	6112	5506	5088	4375	3554	2886		3.44	5746	2.35	11000	9000
	432.36	6730	6194	6194	6193	4588	3727	3027		3.24	6194	2.39	11000	9000
	507.55	6601	6100	5495	5078	4375	3554	2886		2.76	5881	1.93	11000	9000
	543.55	6730	6194	6194	6193	4504	3658	2972		2.58	6194	1.90	11000	9000
	585.10	6730	6194	6194	6193	4588	3727	3027		2.39	6194	1.76	11000	9000
	607.15	6738	6352	6352	6348	4010	3257	2646		2.31	6352	1.75	10000	9000
	716.77	6730	6194	6194	6193	4504	3658	2972		1.95	6194	1.44	11000	9000
	821.64	5672	5241	4722	4363	3780	3164	2570		1.70	5338	1.08	10000	9000
	894.53	6730	6194	6194	6193	4504	3658	2972		1.57	6394	1.19	11000	9000
	969.99	6571	6072	5470	5054	4375	3554	2886		1.44	6302	1.08	11000	9000
	1122.55	5687	5192	5192	5191	4572	3889	3159		1.25	5545	0.82	9500	9000
	1210.55	6562	6064	5463	5048	4375	3554	2886		1.16	6454	0.89	11000	9000
	1339.20	5104	4623	4499	4158	3461	3198	3125		1.05	5078	0.63	8050	8050
	1519.12	5687	5192	5192	5191	4568	3889	3159		0.92	5741	0.63	9500	9000
	1895.86	5245	4847	4366	4035	3670	3475	3159		0.74	5429	0.48	9500	9000
	2203.94	5104	4623	4493	4152	3456	3194	3121		0.64	5376	0.41	8050	8050
	2666.06	3781	3494	3147	2908	2421	2271	2224		0.53	4101	0.26	6000	6000



P _{tn}	P	R-L-F-FC-FU FB-FCB	M MX	FS FP	T
502	17,6	13,8	15,1	11,9	17,0
503	12,7	10,1	11,0	8,8	12,4
504	9,8	7,9	8,5	6,9	9,5

1.2 Prestazioni

1.2 Performances

1.2 Leistungen

EX 	n ₂ X h								10000 Hours Life				T _{max} [Nm]	Only Output Version FC
	Stadio Stage Stufe	ir	T _N [Nm]						P ₁ [kW]	T _{max} [Nm]				
10000			20000	50000	100000	500000	1000000	2000000			n ₁ [rpm]	n ₂ [rpm]	T _N [Nm]	P ₁ [kW]
1	3.60	8568	8032	8031	8031	6676	5423	4405	1400	388.89	3608	151.47	12000	9000
	4.55	7691	7049	7049	7048	6246	5294	4300		307.69	3779	125.52	13000	
	5.33	6636	6057	6057	6057	5559	5156	4212		262.66	3881	110.04	11500	
2	12.53	7822	7822	7820	7818	5446	4424	3593	1400	111.73	4279	53.26	12000	
	15.82	7691	7049	7049	7048	5979	5208	4230		88.50	5403	53.27	13000	
	19.38	7691	7049	7049	7048	5948	5113	4153		72.24	5637	45.36	13000	
	22.74	6636	6057	6057	6057	5315	4929	4212		61.57	5190	35.60	11500	
	26.22	7691	7049	7049	6668	5908	4966	4034		53.39	5864	34.88	13000	
	30.77	6636	6057	6057	6057	5281	4899	4212		45.50	5338	27.06	11500	
3	43.60	7697	7696	7693	7688	5260	4272	3470	1400	32.11	6007	21.95	12000	
	53.41	7876	7876	7875	7671	5347	4343	3528		26.21	6490	19.36	12000	
	65.43	7852	7852	7851	7636	5347	4343	3528		21.40	6897	16.80	12000	
	72.28	7603	7602	7599	7593	5016	4074	3309		19.37	6666	14.70	12000	
	82.61	7691	7049	7049	6965	5798	5113	4153		16.95	6558	12.65	13000	
	88.54	7820	7820	7819	7589	5347	4343	3528		15.81	7203	12.96	12000	
	91.26	7691	7049	7049	6956	5791	4796	3896		15.34	6625	11.57	13000	
	111.80	7691	7049	7049	6941	5778	5113	4153		12.52	6765	9.64	13000	
	139.52	7691	7049	7049	6925	5765	5113	4153		10.03	6922	7.90	13000	
	151.29	7691	7049	6916	6391	5761	4966	4034		9.25	6448	6.79	13000	
	188.81	7691	7049	6893	6370	5745	4966	4034		7.41	6590	5.56	13000	
	221.54	6636	6057	6057	6057	5153	4779	4212		6.32	6057	4.36	11500	
4	151.72	7501	7500	7497	7491	5260	4272	3470	1400	9.23	7492	8.14	12000	
	185.86	7760	7760	7759	7501	5347	4343	3528		7.53	7747	6.86	12000	
	227.69	7747	7747	7746	7481	5347	4343	3528		6.15	7745	5.60	12000	
	278.93	7735	7735	7734	7464	5347	4343	3528		5.02	7734	4.57	12000	
	308.13	7730	7730	7729	7456	5347	4343	3528		4.54	7729	4.13	12000	
	352.19	7691	7049	7049	6876	5724	5113	4153		3.98	7049	3.30	13000	
	384.54	7719	7719	7718	7440	5347	4343	3528		3.64	7718	3.31	12000	
	416.98	7411	7410	7406	7298	5016	4074	3309		3.36	7408	2.93	12000	
	471.08	7710	7710	7709	7427	5347	4343	3528		2.97	7709	2.69	12000	
	510.82	7707	7706	7705	7422	5347	4343	3528		2.74	7706	2.48	12000	
	559.22	6636	6057	6057	6057	5125	4753	4212		2.50	6057	1.78	11500	
	637.51	7698	7698	7697	7409	5347	4343	3528		2.20	7698	1.99	12000	
	756.77	6636	6057	6057	6057	5118	4747	4212		1.85	6185	1.35	11500	
	804.93	7691	7049	7049	6848	5701	5113	4153		1.74	7219	1.48	13000	
	872.83	7691	7049	6789	6273	5658	4966	4034		1.60	7286	1.37	13000	
	1004.56	7320	6764	6094	5926	5200	4731	3843		1.39	7049	1.15	13000	
	1178.68	6636	6057	6057	6057	5110	4739	4212		1.19	6506	0.91	11500	
	1278.11	6636	6057	6057	6057	5108	4738	4212		1.10	6567	0.85	11500	
	1359.44	7691	7049	6771	6256	5643	4966	4034		1.03	7666	0.93	13000	
	1595.08	7691	7049	6765	6251	5639	4966	4034		0.88	7807	0.81	13000	

5-6

5,6 stadi/stages/stufen
A richiesta / On request / Auf Anfrage

P _{EN}	P	R-L-F-FC-FU FB-FCB	M MX	FS FP	T
701	31.4	21.0	24.6	15.8	29.9
702	21.6	15.7	17.7	12.7	20.8
703	13.5	10.0	11.2	8.3	13.0
704	10.8	8.2	9.1	6.9	10.4

1.2 Prestazioni

1.2 Performances

1.2 Leistungen

EXB		n ₂ X h								10000 Hours Life				T _{max} [Nm]	
Stadio Stage Stufe	ir	T _N [Nm]								n ₁ [rpm]	n ₂ [rpm]	T _N [Nm]	P ₁ [kW]	T _{max} [Nm]	Only Output Version FC
		10000	20000	50000	100000	500000	1000000	2000000	9000						
2	9.11	4708	4708	4707	4706	4698	4687	4405	1400	1400	153.68	4676	81.79	12000	
	11.50	5944	5944	5943	5941	5928	5294	4300			121.74	4991	69.16	13000	
	13.49	6636	6057	6057	6057	5385	4994	4212			103.78	4991	58.95	11500	
	18.94	5202	5160	5159	5159	4585	4289	4202			73.92	4386	36.90	13000	
	22.22	6054	6054	6054	6053	5283	4932	4212			63.01	5146	36.91	11500	
	31.31	4593	4244	3824	3533	2941	2875	2779			44.71	2979	15.16	13000	
	36.74	5292	4890	4405	4071	3420	3353	3222			38.11	3495	15.16	11500	
3	36.02	6375	6374	6373	6371	5446	4424	3593	1400	1400	38.87	5874	26.56	12000	
	44.12	7809	7808	7807	7708	5347	4343	3528			31.73	6128	22.62	12000	
	55.71	7691	7049	7049	7002	5829	5113	4153			25.13	6304	18.43	13000	
	65.91	7180	7049	7049	6619	5815	5208	4230			21.24	6075	15.01	13000	
	75.39	7691	7049	7006	6474	5804	4966	4034			18.57	6033	13.03	13000	
	80.74	7691	7049	7049	6967	5799	5113	4153			17.34	6543	13.20	13000	
	88.46	6636	6057	6057	6057	5197	4821	4212			15.83	5925	10.91	11500	
	94.74	6636	6057	6057	6057	5193	4817	4212			14.78	5967	10.26	11500	
	109.27	7691	7049	6954	6426	5779	4966	4034			12.81	6247	9.31	13000	
	128.21	6636	6057	6057	6057	5177	4802	4212			10.92	6057	7.70	11500	
	155.91	5907	5458	4917	4544	4219	3864	3817			8.98	4600	4.81	11500	
	179.82	6703	6194	5580	5194	4802	4402	4034			7.79	5305	4.81	13000	
	210.99	6636	6057	6057	6057	5155	4781	4212			6.64	6057	4.68	11500	
4	125.34	7524	7523	7520	7514	5260	4272	3470	1400	1400	11.17	7513	9.99	12000	9000
	153.55	7773	7773	7772	7520	5347	4343	3528			9.12	7600	8.25	12000	
	188.11	7759	7759	7758	7499	5347	4343	3528			7.44	7756	6.87	12000	
	222.54	7748	7748	7747	7484	5347	4343	3528			6.29	7747	5.80	12000	
	254.56	7740	7740	7739	7472	5347	4343	3528			5.50	7739	5.06	12000	
	272.62	7736	7736	7735	7466	5347	4343	3528			5.14	7735	4.73	12000	
	321.41	7691	7049	7049	6880	5727	5113	4153			4.36	7049	3.66	13000	
	366.23	7721	7721	7720	7444	5347	4343	3528			3.82	7720	3.51	12000	
	401.12	7691	7049	7049	6871	5720	5113	4153			3.49	7049	2.93	13000	
	448.65	7712	7712	7711	7430	5347	4343	3528			3.12	7711	2.86	12000	
	495.61	7399	7398	7395	7279	5016	4074	3309			2.82	7397	2.48	12000	
	542.83	7691	7049	6813	6296	5679	4966	4034			2.58	7049	2.16	13000	
	607.15	7700	7700	7699	7412	5347	4343	3528			2.31	7699	2.12	12000	
	682.11	6636	6057	6057	6057	5120	4749	4212			2.05	6057	1.48	11500	
	757.72	7149	6606	5951	5773	5086	4343	3528			1.85	6666	1.47	12000	
	821.64	6625	6122	5515	5096	4520	4218	3426			1.70	6235	1.26	12000	
	899.48	6636	6057	6057	6057	5114	4744	4212			1.56	6308	1.17	11500	
	956.72	7691	7049	7049	6844	5697	5113	4153			1.46	7363	1.28	13000	
	1037.42	7691	7049	6781	6266	5652	4966	4034			1.35	7432	1.19	13000	
	1122.55	6636	6057	6057	6057	5110	4740	4212			1.25	6470	0.96	11500	
1294.71	7691	7049	6772	6258	5645	4966	4034	1.08	7623	0.98	13000				
1519.12	6636	6057	6057	6057	5106	4736	4212	0.92	6698	0.73	11500				



P _{tn}	P	R-L-F-FC-FU FB-FCB	M MX	FS FP	T
702	17,6	13,8	15,1	11,9	17,0
703	12,7	10,1	11,0	8,8	12,4
704	9,8	7,9	8,5	6,9	9,5



1.2 Prestazioni

1.2 Performances

1.2 Leistungen

EX 	n ₂ X h								10000 Hours Life				T _{max} [Nm]
	Stadio Stage Stufe	ir	T _N [Nm]						n ₁ [rpm]	n ₂ [rpm]	T _N [Nm]	P ₁ [kW]	
10000			20000	50000	100000	500000	1000000	2000000					
1	3.50	9011	8496	8495	8494	6093	4949	4020	1400	400.00	3265	140.98	16500
	4.13	9693	8919	8919	8918	6043	4909	3987		338.98	3403	124.53	16000
	5.17	8484	7741	7741	7740	5874	4771	3876		270.79	3539	103.45	14500
	6.00	7934	7210	7210	6839	5693	4666	3790		233.33	3619	91.16	11500
	7.25	6309	5830	5252	4853	4040	3775	3700		193.10	3705	77.23	9000
2	12.60	8522	8035	8034	8033	6093	4949	4020	1400	111.11	4795	59.35	16500
	14.85	9693	8919	8919	8918	6043	4909	3987		94.28	4996	52.47	16000
	17.53	9693	8919	8919	8918	6043	4909	3987		79.86	5251	46.71	16000
	18.67	8421	7939	7938	7937	6093	4949	4020		74.99	5395	45.07	16500
	22.00	9693	8919	8919	8918	6043	4909	3987		63.64	5621	39.85	16000
	25.58	9693	8919	8794	8127	6043	4909	3987		54.73	5882	35.86	16000
	27.56	8484	7741	7741	7740	5874	4771	3876		50.80	5846	33.08	14500
	32.03	8484	7741	7741	7740	5874	4771	3876		43.71	6116	29.78	14500
	37.20	7934	7210	7022	6489	5402	4666	3790		37.63	5579	23.39	11500
	38.75	8484	7741	7741	7188	5874	4771	3876		36.13	6476	26.06	14500
	45.00	7934	7210	6998	6467	5383	4666	3790		31.11	5682	19.69	11500
	54.38	5996	5541	4992	4613	3840	3588	3516		25.74	4141	11.87	9000
	3	43.85	8257	7784	7784	7782	5281	4289		3484	1400	31.93	6042
51.68		9693	8919	8919	8918	5925	4812	3909	27.09	7120		21.95	16000
63.31		9693	8919	8919	8918	5816	4724	3837	22.11	7429		18.70	16000
76.56		9693	8919	8919	8918	6043	4909	3987	18.29	8172		17.01	16000
85.67		9693	8919	8919	8918	5650	4589	3727	16.34	7902		14.70	16000
93.79		9693	8919	8919	8918	6043	4909	3987	14.93	8685		14.76	16000
101.14		9693	8919	8919	8918	6043	4909	3987	13.84	8884		13.99	16000
109.03		9693	8919	8436	7795	6043	4909	3987	12.84	7576		11.07	16000
126.92		9693	8919	8919	8918	6043	4909	3987	11.03	8918		11.20	16000
147.55		9693	8919	8387	7751	6043	4909	3987	9.49	7797		8.42	16000
158.40		9693	8919	8688	8499	6043	4909	3987	8.84	8542		8.59	16000
184.14		9693	8919	8356	7722	6043	4909	3987	7.60	7967		6.89	16000
230.64		8484	7741	7741	7740	5874	4771	3876	6.07	7741		5.35	14500
267.84		7934	7210	6857	6336	5275	4666	3790	5.23	6822		4.06	11500
279.00		8484	7741	7427	6863	5874	4771	3876	5.02	7424		4.24	14500
324.00		7934	7210	6848	6328	5268	4666	3790	4.32	6963		3.42	11500
391.50		5881	5434	4895	4524	3766	3519	3449	3.58	5086		2.07	9000
4	212.31	9693	8919	8919	8918	6043	4909	3987	1400	6.59	8919	6.92	16000
	260.09	9693	8919	8919	8918	6043	4909	3987		5.38	8919	5.65	16000
	298.14	9693	8919	8919	8918	5925	4812	3909		4.70	8919	4.93	16000
	318.62	9693	8919	8919	8918	6043	4909	3987		4.39	8919	4.61	16000
	351.97	9693	8919	8919	8918	6043	4909	3987		3.98	8919	4.18	16000
	399.84	9693	8919	8919	8918	6043	4909	3987		3.50	8919	3.67	16000
	455.82	9693	8919	8919	8918	5816	4724	3837		3.07	8919	3.22	16000
	494.27	9693	8919	8919	8620	5650	4589	3727		2.83	8919	2.97	16000
	538.12	9693	8919	8919	8918	6043	4909	3987		2.60	8919	2.73	16000
	551.23	9693	8919	8433	8249	6043	4909	3987		2.54	8919	2.67	16000
	629.02	9693	8919	8234	7608	6043	4909	3987		2.23	8919	2.34	16000
	728.22	9693	8919	8919	8918	6043	4909	3987		1.92	8919	2.01	16000
	785.02	9693	8919	8219	7594	6043	4909	3987		1.78	8919	1.87	16000
	851.24	9693	8919	8213	7590	6043	4909	3987		1.64	9157	1.77	16000
	913.85	9693	8919	8919	8918	6043	4909	3987		1.53	9231	1.66	16000
	1062.35	9693	8919	8200	7578	6043	4909	3987		1.32	9392	1.46	16000
	1140.48	9693	8919	8342	8160	6043	4909	3987		1.23	9468	1.37	16000
	1325.81	9693	8919	8189	7567	6043	4909	3987		1.06	9633	1.20	16000
	1428.48	8484	7741	7741	7740	5874	4771	3876		0.98	8504	0.98	14500
	1660.61	8484	7741	7741	7740	5874	4771	3876		0.84	8652	0.86	14500
	1869.23	7934	7210	6796	6280	5228	4666	3790		0.75	8201	0.72	11500
	2008.80	8484	7741	7293	6739	5874	4771	3876		0.70	8842	0.73	14500
	2332.80	7934	7210	6792	6276	5225	4666	3790		0.60	8411	0.59	11500
2818.80	5838	5394	4860	4491	3738	3493	3423	0.50	6395	0.38	9000		

5-6 5,6 stadi/stages/stufen
A richiesta / On request / Auf Anfrage

P _{TN}	P	R-L-F-FC-FU FB-FCB	M MX	FS FP	T
801	42.2	27.7	29.4	20.1	40.5
802	28.7	20.4	21.4	16.0	27.7
803	17.6	12.8	13.4	10.2	17.1
804	13.9	10.3	10.7	8.4	13.5

1.2 Prestazioni

1.2 Performances

1.2 Leistungen

Stadio Stage Stufe	ir	n ₂ X h							10000 Hours Life				T _{max} [Nm]
		T _N [Nm]							n ₁ [rpm]	n ₂ [rpm]	T _N [Nm]	P ₁ [kW]	
		10000	20000	50000	100000	500000	1000000	2000000					
2	8.85	6247	6247	6246	6245	6093	4949	4020	1400	158.19	4313	77.65	16500
	10.43	7363	7362	7361	7359	6043	4909	3987		134.23	4494	68.66	16000
	13.07	8484	7741	7741	7740	5874	4771	3876		107.12	4674	56.99	14500
	15.18	7934	7210	7169	6625	5515	4666	3790		92.23	4781	50.19	11500
	17.19	6509	6457	6456	6456	5890	4909	3987		81.44	5220	48.39	16000
	21.53	8087	7741	7741	7740	5874	4771	3876		65.03	5429	40.18	14500
	25.00	7934	7210	7080	6542	5446	4666	3790		56.00	5376	34.27	11500
	30.21	6059	5599	5044	4661	3880	3626	3553		46.34	3914	20.64	9000
	35.59	6063	5602	5047	4664	3907	3833	3687		39.34	3990	17.87	14500
	41.33	6922	6396	5762	5325	4523	4424	3790		33.87	4633	17.86	11500
49.94	6004	5548	4998	4619	3845	3593	3521	28.03	4107	13.10	9000		
3	36.23	6411	6411	6410	6408	6093	4949	4020	1400	38.64	6375	28.66	16500
	42.77	7569	7568	7567	7562	6093	4949	4020		32.73	6918	26.34	16500
	50.40	8920	8919	8917	8910	6043	4909	3987		27.78	7209	23.30	16000
	63.25	9693	8919	8919	8918	6043	4909	3987		22.13	7717	19.87	16000
	73.53	9693	8919	8511	7864	6043	4909	3987		19.04	7308	16.19	16000
	79.22	8484	7741	7741	7740	5874	4771	3876		17.67	7566	15.55	14500
	91.67	9693	8919	8919	8866	6043	4909	3987		15.27	8448	15.01	16000
	106.56	9693	8919	8440	7799	6043	4909	3987		13.14	7560	11.56	16000
	114.81	8484	7741	7741	7740	5874	4771	3876		12.19	7740	10.98	14500
	133.47	8484	7741	7741	7740	5874	4771	3876		10.49	7740	9.45	14500
	161.46	8484	7741	7494	6925	5874	4771	3876		8.67	7038	7.10	14500
	187.50	7934	7210	6876	6354	5289	4666	3790		7.47	6569	5.71	11500
	219.66	8003	7395	6662	6317	5737	4771	3876		6.37	6480	4.80	14500
	265.71	8484	7741	7432	6868	5874	4771	3876		5.27	7388	4.53	14500
	308.57	7934	7210	6850	6330	5269	4666	3790		4.54	6927	3.66	11500
	372.86	5882	5436	4897	4525	3767	3520	3450		3.75	5059	2.21	9000
4	148.57	9693	8919	8919	8918	5925	4812	3909	1400	9.42	8918	10.00	16000
	182.01	9693	8919	8919	8918	5816	4724	3837		7.69	8919	8.16	16000
	214.87	9693	8919	8919	8918	6043	4909	3987		6.52	8919	6.92	16000
	263.78	9693	8919	8919	8918	5816	4724	3837		5.31	8919	5.64	16000
	290.78	9693	8919	8919	8918	6043	4909	3987		4.81	8919	5.10	16000
	319.00	9693	8919	8919	8918	6043	4909	3987		4.39	8919	4.66	16000
	364.90	9693	8919	8919	8918	6043	4909	3987		4.39	8919	4.66	16000
	390.79	9693	8919	8919	8918	6043	4909	3987		3.84	8919	4.08	16000
	421.42	9693	8919	8919	8918	6043	4909	3987		3.58	8919	3.80	16000
	455.40	9693	8919	8463	8278	6043	4909	3987		3.32	8919	3.52	16000
	512.49	9693	8919	8919	8918	6043	4909	3987		3.07	8774	3.21	16000
	587.47	9693	8919	8919	8597	5650	4589	3727		2.73	8919	2.90	16000
	660.00	9693	8919	8407	8224	6043	4909	3987		2.38	8919	2.53	16000
	693.54	9693	8919	8919	8918	6043	4909	3987		2.12	8919	2.25	16000
	767.25	9693	8919	8220	7596	6043	4909	3987		2.02	8919	2.14	16000
	870.33	9693	8919	8919	8918	6043	4909	3987		1.82	8919	1.93	16000
	1011.76	9693	8919	8203	7580	6043	4909	3987		1.61	9180	1.76	16000
	1086.17	9693	8919	8347	8165	6043	4909	3987		1.38	9339	1.53	16000
	1262.67	9693	8919	8191	7569	6043	4909	3987		1.29	9416	1.45	16000
	1360.46	8484	7741	7741	7740	5874	4771	3876		1.11	9579	1.27	16000
	1532.97	8484	7741	7305	6750	5874	4771	3876		1.03	8456	1.04	14500
	1836.62	7934	7210	6796	6280	5228	4666	3790		0.91	8573	0.93	14500
	1913.14	8484	7741	7295	6741	5874	4771	3876		0.76	8184	0.74	11500
	2221.71	7934	7210	6793	6277	5225	4666	3790		0.73	8793	0.76	14500
2684.57	5838	5395	4860	4491	3739	3494	3424	0.63	8365	0.63	11500		
								0.52	6349	0.39	9000		



B

P _{TN}	P	R-L-F-FC-FU FB-FCB	M MX	FS FP	T
802	23,6	18,3	18,9	15,5	23,0
803	16,9	13,3	13,7	11,4	16,5
804	12,8	10,1	10,4	8,7	12,5



1.2 Prestazioni

1.2 Performances

1.2 Leistungen

EX		$n_2 \times h$							10000 Hours Life				T_{max} [Nm]
Stadio Stage Stufe	ir	T_N [Nm]							n_1 [rpm]	n_2 [rpm]	T_N [Nm]	P_1 [kW]	
		10000	20000	50000	100000	500000	1000000	2000000					
2	12.60	11694	11572	11571	10943	6752	5485	4455	1400	111.11	5314	65.77	24000
	14.85	13782	12807	12806	12277	7575	6153	4998		94.28	6263	65.78	23000
	17.53	12690	12689	12687	12100	7466	6064	4926		79.86	6487	57.71	23000
	18.60	11348	10354	10353	10353	8052	6540	5313		75.27	7122	59.72	18000
	21.96	11348	10354	10353	10353	8052	6540	5313		63.75	7486	53.16	18000
	25.58	9857	9762	8794	8127	7166	5821	4728		54.73	6975	42.52	23000
	27.56	11348	10354	10353	10353	8052	6540	5313		50.80	8014	45.35	18000
	32.03	11348	10354	10353	9921	8052	6540	5313		43.71	8384	40.82	18000
	37.20	10772	9790	9486	8766	7297	6396	5196		37.63	7537	31.59	15000
	45.00	10668	9790	8881	8206	7272	6396	5196		31.11	7676	26.60	15000
54.38	8495	7850	7072	6535	5440	5084	4982	25.74	5868	16.83	11000		
3	43.85	11694	11211	10537	8559	5281	4289	3484	1400	31.93	6042	21.96	24000
	51.68	13782	12807	11821	9602	5925	4812	3909		27.09	7120	21.95	23000
	63.31	13782	12807	11605	9426	5816	4724	3837		22.11	7429	18.70	23000
	76.42	11348	10354	10353	10353	7791	6328	5140		18.32	9997	20.85	18000
	85.67	11429	10561	9514	8994	5650	4589	3727		16.34	7902	14.70	23000
	93.61	11348	10354	10353	10353	7648	6212	5046		14.96	10205	17.38	18000
	101.14	12690	12234	11021	10284	6346	5154	4187		13.84	9329	14.70	23000
	111.48	11348	10354	10343	9558	8052	6540	5313		12.56	9313	13.31	18000
	126.92	10890	10889	10887	10123	7243	5883	4779		11.03	10011	12.57	23000
	147.55	9857	9310	8387	7751	6839	5821	4728		9.49	7797	8.42	23000
	158.97	11348	10354	10353	10353	8052	6540	5313		8.81	10353	10.38	18000
	184.81	11348	10354	10239	9462	8052	6540	5313		7.58	9766	8.43	18000
	230.64	11348	10354	10201	9427	8052	6540	5313		6.07	9978	6.89	18000
	267.84	10772	9790	9263	8560	7126	6396	5196		5.23	9217	5.49	15000
	279.00	8922	8244	7427	6863	6249	5911	5313		5.02	7424	4.24	18000
	324.00	10185	9412	8479	7835	7116	6396	5196		4.32	8621	4.24	15000
391.50	8332	7699	6936	6409	5335	4986	4886	3.58	7206	2.94	11000		
4	179.84	13245	12807	11821	9602	5925	4812	3909	1400	7.78	10351	9.47	23000
	212.31	12690	12689	12687	10785	6655	5405	4390		6.59	12220	9.47	23000
	260.09	12690	12689	12687	10785	6655	5405	4390		5.38	12686	8.03	23000
	298.14	13082	12807	11821	9602	5925	4812	3909		4.70	12046	6.66	23000
	318.62	12690	12689	12687	10588	6533	5307	4310		4.39	12687	6.55	23000
	351.97	12690	12689	12687	10785	6655	5405	4390		3.98	12687	5.94	23000
	386.75	11275	10932	10344	8402	5185	4211	3421		3.62	10931	4.66	24000
	455.82	13289	12807	11605	9426	5816	4724	3837		3.07	12807	4.63	23000
	500.81	11348	10354	10353	10353	8052	6540	5313		2.80	10354	3.41	18000
	538.12	12690	12689	12687	10588	6533	5307	4310		2.60	12688	3.88	23000
	583.51	12689	11725	10563	10134	6346	5154	4187		2.40	11485	3.24	23000
	619.08	11348	10354	10353	10353	6614	5372	4364		2.26	10354	2.75	18000
	728.22	12647	11687	10528	10101	6346	5154	4187		1.92	11739	2.65	23000
	802.63	11348	10354	10050	9287	8052	6540	5313		1.74	10648	2.18	18000
	845.81	11348	10354	10353	10353	8052	6540	5313		1.66	10712	2.09	18000
	917.16	11348	10354	10353	10353	8052	6540	5313		1.53	10811	1.95	18000
	1066.20	11348	10354	10027	9266	8052	6540	5313		1.31	10999	1.70	18000
	1144.62	11348	10354	10353	10353	8052	6540	5313		1.22	11089	1.59	18000
	1330.62	11348	10354	10011	9251	8052	6540	5313		1.05	11282	1.39	18000
	1428.48	11348	10354	10353	10107	8052	6540	5313		0.98	11374	1.31	18000
	1660.61	11348	10354	9997	9238	8052	6540	5313		0.84	11571	1.14	18000
	1928.45	10772	9790	9180	8483	7062	6396	5196		0.73	11175	0.96	15000
	2008.80	8761	8096	7293	6739	6137	5805	5313		0.70	9129	0.75	18000
	2332.80	10002	9243	8326	7694	7058	6396	5196		0.60	10601	0.75	15000
2818.80	8271	7643	6885	6362	5296	4949	4850	0.50	9060	0.53	11000		

5-6

5,6 stadi/stages/stufen
A richiesta / On request / Auf Anfrage

P_{TN}	P	R-L-F-FC-FU FB-FCB	FS FP	T
902	30.4	25.6	16.9	28.6
903	18.6	15.8	10.8	17.6
904	14.6	12.6	8.7	13.9

1.2 Prestazioni

1.2 Performances

1.2 Leistungen

Stadio Stage Stufe	ir	$n_2 \times h$							10000 Hours Life				T_{max} [Nm]
		T_N [Nm]							n_1 [rpm]	n_2 [rpm]	T_N [Nm]	P_1 [kW]	
		10000	20000	50000	100000	500000	1000000	2000000					
3	36.23	6411	6411	6410	6408	6362	5485	4455	1400	38.64	6375	28.66	24000
	42.77	7569	7568	7567	7562	6655	5405	4390		32.73	7526	28.66	24000
	53.48	9464	9463	9460	9451	8052	6540	5313		26.18	9411	28.67	18000
	63.13	11173	10354	10353	10353	8052	6540	5313		22.18	9809	25.31	18000
	73.31	10772	9790	9384	8672	7219	6396	5196		19.10	8055	17.90	15000
	79.22	11348	10354	10353	10353	8052	6540	5313		17.67	10034	20.63	18000
	92.10	11348	10354	10353	9601	8052	6540	5313		15.20	9153	16.19	18000
	106.95	10772	9790	9341	8631	7185	6396	5196		13.09	8370	12.75	15000
	114.81	11348	10354	10353	10353	8052	6540	5313		12.19	10352	14.68	18000
	133.47	11348	10354	10303	9521	8052	6540	5313		10.49	9469	11.56	18000
	155.00	10772	9790	9305	8598	7158	6396	5196		9.03	8699	9.14	15000
	187.50	10277	9497	8555	7906	7146	6396	5196		7.47	8173	7.10	15000
	219.66	8003	7395	6662	6317	5737	5377	5313		6.37	6480	4.80	18000
	255.09	9137	8443	7606	7308	6530	6244	5196		5.49	7526	4.81	15000
	308.57	10193	9419	8485	7841	7119	6396	5196		4.54	8579	4.53	15000
	372.86	8334	7701	6938	6411	5337	4987	4888		3.75	7168	3.13	11000
	4	148.57	13317	12807	11821	9602	5925	4812		3909	1400	9.42	9774
182.01		13462	12807	11605	9426	5816	4724	3837	7.69	10199		9.33	23000
214.87		12690	12689	12687	10588	6533	5307	4310	6.52	12040		9.34	23000
263.78		13382	12807	11605	9426	5816	4724	3837	5.31	11399		7.20	23000
290.78		12690	11879	10701	10267	6346	5154	4187	4.81	10747		6.15	23000
319.00		10890	10889	10799	9979	7243	5883	4779	4.39	10888		5.69	23000
364.90		10890	10889	10781	9962	7243	5883	4779	3.84	10888		4.98	23000
390.79		10890	10889	10773	9955	7243	5883	4779	3.58	10888		4.64	23000
421.42		12690	11790	10622	10191	6346	5154	4187	3.32	11128		4.40	23000
455.40		9972	9214	8463	8278	7192	5883	4779	3.07	8774		3.21	23000
512.49		12690	12689	12687	10588	6533	5307	4310	2.73	12688		4.12	23000
587.47		10925	10095	9094	8597	5650	4589	3727	2.38	9896		2.80	23000
643.13		10890	10889	10719	9905	7243	5883	4779	2.18	10889		2.82	23000
693.54		12656	11695	10535	10108	6346	5154	4187	2.02	11682		2.81	23000
764.41		11348	10354	10054	9291	8052	6540	5313	1.83	10588		2.31	18000
870.33		10890	10889	10693	9881	7243	5883	4779	1.61	10889		2.09	23000
961.00		11348	10354	10035	9273	8052	6540	5313	1.46	10869		1.89	18000
1090.11		11348	10354	10353	10353	8052	6540	5313	1.28	11027		1.68	18000
1267.25		11348	10354	10014	9254	8052	6540	5313	1.10	11219		1.47	18000
1360.46		11348	10354	10353	10113	8052	6540	5313	1.03	11310		1.39	18000
1581.53		11348	10354	10000	9240	8052	6540	5313	0.89	11507		1.22	18000
1836.62		10772	9790	9181	8484	7063	6396	5196	0.76	11112		1.00	15000
2221.71		10005	9245	8329	7696	7059	6396	5196	0.63	10545		0.79	15000
2684.57		8272	7644	6886	6363	5297	4950	4851	0.52	8995		0.56	11000



P_{tN}	P	R-L-F-FC-FU FB-FCB	FS FP	T
903	17,6	15,6	11,7	16,9
904	13,3	11,8	9,0	12,8



1.2 Prestazioni

1.2 Performances

1.2 Leistungen

EX 	$n_2 \times h$								10000 Hours Life				T_{max} [Nm]
	Stadio Stage Stufe	ir	T_N [Nm]								n_1 [rpm]	n_2 [rpm]	
10000			20000	50000	100000	500000	1000000	2000000					
2	12.60	12274	11572	11571	11569	8352	6784	5510	1400	111.11	6573	81.36	24000
	14.85	13918	12807	12806	12806	8284	6729	5465		94.28	6849	71.93	23000
	17.53	13918	12807	12806	12806	8284	6729	5465		79.86	7198	64.03	23000
	18.67	11200	11199	11198	10768	8352	6784	5510		74.99	7396	61.78	24000
	22.00	13199	12807	12806	12456	8284	6729	5465		63.64	7706	54.63	23000
	25.58	11923	11375	10248	9470	8284	6729	5465		54.73	8062	49.15	23000
	27.56	11348	10354	10353	10353	8052	6540	5313		50.80	8014	45.35	18000
	32.03	11348	10354	10353	10353	8052	6540	5313		43.71	8384	40.82	18000
	37.20	10772	9790	9486	8766	7297	6396	5196		37.63	7537	31.59	15000
	44.95	8521	7874	7094	6555	5457	5099	4997		31.15	5759	19.98	11000
3	43.85	11759	11211	10537	8559	5281	4289	3484	1400	31.93	6042	21.96	24000
	51.68	13857	12807	11821	9602	5925	4812	3909		27.09	7120	21.95	23000
	61.01	13918	12807	12806	10785	6655	5405	4390		22.95	8406	21.96	23000
	76.56	13199	12807	12806	11965	7801	6336	5147		18.29	10549	21.96	23000
	89.00	11860	10959	9873	9123	8223	6729	5465		15.73	8664	15.51	23000
	93.79	13199	12807	12806	11908	7659	6221	5053		14.93	11006	18.70	23000
	101.14	13239	12234	11021	10284	6346	5154	4187		13.84	9329	14.70	23000
	111.48	11348	10354	10353	10353	8052	6540	5313		12.56	10352	14.80	18000
	126.92	13199	12807	12806	11834	7439	6042	4908		11.03	11702	14.69	23000
	147.55	11741	10849	9774	9031	8140	6714	5453		9.49	9086	9.81	23000
	158.97	11348	10354	10353	10353	8052	6540	5313		8.81	10353	10.38	18000
	184.81	11348	10354	10353	10353	8052	6540	5313		7.58	10353	8.93	18000
	230.64	11348	10354	10353	10353	8052	6540	5313		6.07	10353	7.15	18000
	267.84	10772	9790	9263	8560	7126	6396	5196		5.23	9217	5.49	15000
	323.64	8341	7708	6944	6417	5341	4991	4892		4.33	7059	3.48	11000
4	179.84	13245	12807	11821	9602	5925	4812	3909	1400	7.78	10351	9.47	23000
	212.31	13918	12807	12806	10785	6655	5405	4390		6.59	12220	9.47	23000
	260.09	13918	12807	12806	10785	6655	5405	4390		5.38	12806	8.11	23000
	298.14	13082	12807	11821	9602	5925	4812	3909		4.70	12046	6.66	23000
	318.62	13918	12807	12806	10588	6533	5307	4310		4.39	12807	6.61	23000
	351.97	13918	12807	12806	10785	6655	5405	4390		3.98	12807	6.00	23000
	399.84	13199	12807	12590	11633	7659	6221	5053		3.50	12807	5.27	23000
	455.82	13918	12807	11605	9426	5816	4724	3837		3.07	12807	4.63	23000
	500.81	11348	10354	10353	10353	8052	6540	5313		2.80	10354	3.41	18000
	538.12	13918	12807	12806	10588	6533	5307	4310		2.60	12807	3.92	23000
	551.23	13199	12807	12548	11595	7801	6336	5147		2.54	12807	3.83	23000
	629.02	11526	10650	9594	8866	7991	6729	5465		2.23	10521	2.76	23000
	728.22	12647	11687	10528	10101	6346	5154	4187		1.92	11739	2.65	23000
	785.02	11316	10457	9577	8850	7976	6623	5380		1.78	10594	2.22	23000
	851.24	11497	10624	9571	8844	7971	6714	5453		1.64	10863	2.10	23000
	913.85	13199	12807	12495	11546	7439	6042	4908		1.53	13199	2.38	23000
	1062.35	11479	10607	9556	8830	7959	6714	5453		1.32	11124	1.73	23000
	1144.62	11348	10354	10353	10353	8052	6540	5313		1.22	11089	1.59	18000
	1330.62	11348	10354	10353	10353	8052	6540	5313		1.05	11282	1.39	18000
	1428.48	11348	10354	10353	10107	8052	6540	5313		0.98	11374	1.31	18000
	1660.61	11348	10354	10353	10353	8052	6540	5313		0.84	11571	1.14	18000
	1928.45	10772	9790	9180	8483	7062	6396	5196		0.73	11175	0.96	15000
	2004.48	8278	7649	6891	6367	5301	4953	4854		0.70	8612	0.71	11000
	2330.21	8274	7646	6888	6365	5299	4951	4853		0.60	8807	0.62	11000

5-6

5,6 stadi/stages/stufen
A richiesta / On request / Auf Anfrage

P_{TN}	P	R-L-F-FC-FU FB-FCB	FS FP	T
952	30.4	25.6	16.9	28.6
953	18.6	15.8	10.8	17.6
954	14.6	12.6	8.7	13.9

1.2 Prestazioni

1.2 Performances

1.2 Leistungen

Stadio Stage Stufe	ir	n ₂ X h								10000 Hours Life				T _{max} [Nm]
		T _N [Nm]								η ₁ [rpm]	η ₂ [rpm]	T _N [Nm]	P ₁ [kW]	
		10000	20000	50000	100000	500000	1000000	2000000						
3	36.23	6411	6411	6410	6408	6362	6305	5510	1400	38.64	6375	28.66	24000	
	42.77	7569	7568	7567	7562	7499	6784	5510		32.73	7526	28.66	24000	
	53.48	9464	9463	9460	9451	8052	6540	5313		26.18	9411	28.67	18000	
	63.25	11194	11192	11189	11174	8284	6729	5465		22.13	10578	27.24	23000	
	73.53	11913	11009	9917	9164	8260	6729	5465		19.04	8516	18.86	23000	
	79.22	11348	10354	10353	10353	8052	6540	5313		17.67	10034	20.63	18000	
	92.10	11348	10354	10353	10353	8052	6540	5313		15.20	10188	18.02	18000	
	106.56	11606	10917	9835	9088	8191	6729	5465		13.14	8810	13.47	23000	
	114.81	11348	10354	10353	10353	8052	6540	5313		12.19	10352	14.68	18000	
	133.47	11348	10354	10353	10353	8052	6540	5313		10.49	10352	12.63	18000	
	155.00	10772	9790	9305	8598	7158	6396	5196		9.03	8699	9.14	15000	
	187.29	8375	7739	6972	6442	5363	5012	4912		7.48	6660	5.80	11000	
	219.66	8003	7395	6662	6317	5737	5377	5313		6.37	6480	4.80	18000	
	255.09	9137	8443	7606	7308	6530	6244	5196		5.49	7526	4.81	15000	
	308.23	8344	7710	6946	6419	5343	4993	4893		4.54	7023	3.71	11000	
4	148.57	13317	12807	11821	9602	5925	4812	3909	1400	9.42	9774	10.96	23000	
	175.40	13918	12807	12806	10785	6655	5405	4390		7.98	11539	10.96	23000	
	214.87	13918	12807	12806	10588	6533	5307	4310		6.52	12040	9.34	23000	
	263.78	13918	12807	11605	9426	5816	4724	3837		5.31	11399	7.20	23000	
	290.78	12855	11879	10701	10267	6346	5154	4187		4.81	10747	6.15	23000	
	319.00	13199	12807	12623	11664	7801	6336	5147		4.39	12807	6.69	23000	
	364.90	13199	12807	12603	11646	7439	6042	4908		3.84	12807	5.85	23000	
	390.79	13199	12807	12593	11636	7659	6221	5053		3.58	12807	5.46	23000	
	418.35	13918	12807	11864	10785	6655	5405	4390		3.35	12157	4.85	23000	
	457.05	11348	10354	10353	10353	8052	6540	5313		3.06	10353	3.77	18000	
	512.49	13918	12807	12806	10588	6533	5307	4310		2.73	12807	4.16	23000	
	570.40	11348	10354	10353	10253	8052	6540	5313		2.45	10354	3.02	18000	
	643.13	13199	12807	12530	11579	7659	6221	5053		2.18	12807	3.32	23000	
	693.54	12656	11695	10535	10108	6346	5154	4187		2.02	11682	2.81	23000	
	764.41	11348	10354	10353	10353	8052	6540	5313		1.83	10588	2.31	18000	
	870.33	13199	12807	12499	11550	7439	6042	4908		1.61	13181	2.53	23000	
	961.00	11348	10354	10353	10353	8052	6540	5313		1.46	10869	1.89	18000	
	1090.11	11348	10354	10353	10353	8052	6540	5313		1.28	11027	1.68	18000	
	1267.25	11348	10354	10353	10353	8052	6540	5313		1.10	11219	1.47	18000	
	1360.46	11348	10354	10353	10113	8052	6540	5313		1.03	11310	1.39	18000	
	1581.53	11348	10354	10353	10353	8052	6540	5313		0.89	11507	1.22	18000	
	1836.62	10772	9790	9181	8484	7063	6396	5196		0.76	11112	1.00	15000	
	2219.25	8275	7647	6889	6366	5299	4952	4853		0.63	8743	0.66	11000	

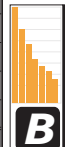

P _{tn}	P	R-L-F-FC-FU FB-FCB	FS FP	T
953	17,6	15,6	11,7	16,9
954	13,3	11,8	9,0	12,8



1.2 Prestazioni

1.2 Performances

1.2 Leistungen

EX 	n ₂ X h								10000 Hours Life				T _{max} [Nm]		
	Stadio Stage Stufe	ir	T _N [Nm]						P ₁ [kW]	T _{max} [Nm]					
10000			20000	50000	100000	500000	1000000	2000000			n ₁ [rpm]	n ₂ [rpm]	T _N [Nm]	P ₁ [kW]	
1	3.50	12978	12235	12234	12232	8352	6784	5510	1400	400.00	4476	193.27	24000		
	4.13	13918	12807	12806	12806	8284	6729	5465		338.98	4665	170.71	23000		
	5.17	11348	10354	10353	10353	8052	6540	5313		270.79	4851	141.80	18000		
	6.00	10772	9790	9789	9239	7691	6396	5196		233.33	4961	124.96	15000		
	7.25	8939	8260	7441	6876	5724	5349	5147		193.10	5201	108.42	11000		
2	12.60	12274	11572	11571	11569	8352	6784	5510	1400	111.11	6573	81.36	24000		
	14.85	13918	12807	12806	12806	8284	6729	5465		94.28	6849	71.93	23000		
	17.53	13918	12807	12806	12806	8284	6729	5465		79.86	7198	64.03	23000		
	18.67	12127	11434	11433	11431	8352	6784	5510		74.99	7396	61.78	24000		
	22.00	13918	12807	12806	12806	8284	6729	5465		63.64	7706	54.63	23000		
	25.58	13918	12807	12806	12806	8284	6729	5465		54.73	8062	49.15	23000		
	27.56	11348	10354	10353	10353	8052	6540	5313		50.80	8014	45.35	18000		
	30.94	13918	12807	11684	10797	8284	6729	5465		45.25	8536	43.03	23000		
	37.20	10772	9790	9486	8766	7297	6396	5196		37.63	7537	31.59	15000		
	38.75	11348	10354	10353	10353	8052	6540	5313		36.13	8877	35.73	18000		
	45.00	10772	9790	9454	8736	7272	6396	5196		31.11	7676	26.60	15000		
	54.38	8495	7850	7072	6535	5440	5084	4982		25.74	5868	16.83	11000		
	3	43.85	11891	11211	11210	11208	8352	6784		5510	1400	31.93	9555	34.72	24000
51.68		13918	12807	12806	12806	8284	6729	5465	27.09	9956		30.70	23000		
63.31		13918	12807	12806	12806	8284	6729	5465	22.11	10581		26.63	23000		
76.56		13918	12807	12806	12806	8284	6729	5465	18.29	11202		23.32	23000		
85.67		13918	12807	12806	12806	8284	6729	5465	16.34	11586		21.55	23000		
93.79		13918	12807	12806	12806	8284	6729	5465	14.93	11905		20.23	23000		
101.14		13918	12807	12806	12806	8284	6729	5465	13.84	12178		19.18	23000		
109.03		13918	12807	12806	12806	8284	6729	5465	12.84	12455		18.20	23000		
126.92		13918	12807	12806	12806	8284	6729	5465	11.03	12775		16.04	23000		
147.55		13918	12807	12806	12806	8284	6729	5465	9.49	12806		13.83	23000		
158.40		13918	12807	12806	12806	8284	6729	5465	8.84	12806		12.88	23000		
184.14		13918	12807	12806	12806	8284	6729	5465	7.60	12806		11.08	23000		
222.75		13401	12383	11155	10308	8284	6729	5465	6.29	10868		7.78	23000		
267.84		10772	9790	9263	8560	7126	6396	5196	5.23	9217		5.49	15000		
279.00		11348	10354	10353	10353	8052	6540	5313	5.02	10353		5.92	18000		
324.00		10772	9790	9251	8549	7116	6396	5196	4.32	9406		4.62	15000		
391.50		8332	7699	6936	6409	5335	4986	4886	3.58	7206		2.94	11000		
4		212.31	13918	12807	12806	12806	8284	6729	5465	1400		6.59	12806	9.93	23000
		260.09	13918	12807	12806	12806	8284	6729	5465			5.38	12806	8.11	23000
	298.14	13918	12807	12806	12806	8284	6729	5465	4.70		12807	7.08	23000		
	318.62	13918	12807	12806	12806	8284	6729	5465	4.39		12807	6.61	23000		
	351.97	13918	12807	12806	12806	8284	6729	5465	3.98		12807	6.00	23000		
	399.84	13918	12807	12806	12796	8284	6729	5465	3.50		12807	5.27	23000		
	455.82	13918	12807	12806	12786	8284	6729	5465	3.07		12807	4.63	23000		
	494.27	13918	12807	12806	12781	8284	6729	5465	2.83		12807	4.26	23000		
	538.12	13918	12807	12806	12775	8284	6729	5465	2.60		12807	3.92	23000		
	583.51	13918	12807	12806	12769	8284	6729	5465	2.40		12807	3.62	23000		
	629.02	13918	12807	12806	12764	8284	6729	5465	2.23		12807	3.36	23000		
	728.22	13918	12807	12806	12756	8284	6729	5465	1.92		12807	2.89	23000		
	785.02	13918	12807	12806	12751	8284	6729	5465	1.78		12807	2.68	23000		
	851.24	13918	12807	12806	12747	8284	6729	5465	1.64		13148	2.54	23000		
	913.85	13918	12807	12806	12743	8284	6729	5465	1.53		13255	2.39	23000		
	1062.35	13918	12807	12806	12736	8284	6729	5465	1.32		13485	2.09	23000		
	1140.48	13918	12807	12806	12732	8284	6729	5465	1.23		13595	1.97	23000		
	1325.81	13918	12807	12806	12725	8284	6729	5465	1.06		13831	1.72	23000		
	1428.48	11348	10354	10353	10353	8052	6540	5313	0.98		11374	1.31	18000		
	1603.80	13159	12160	10955	10123	8284	6729	5465	0.87		13365	1.37	23000		
	1869.23	10772	9790	9181	8484	7062	6396	5196	0.75		11135	0.98	15000		
	2008.80	11348	10354	10353	10353	8052	6540	5313	0.70		11826	0.97	18000		
	2332.80	10772	9790	9176	8479	7058	6396	5196	0.60		11421	0.81	15000		
2818.80	8271	7643	6885	6362	5296	4949	4850	0.50	9060	0.53	11000				

5-6 5,6 stadi/stages/stufen
A richiesta / On request / Auf Anfrage

P _{TN}	P	R-L-F-FC-FU FB-FCB	FS FP	T
1001	45.2	36.9	21.6	42.1
1002	31.1	26.4	17.7	29.4
1003	20.3	17.5	12.5	19.3
1004	15.9	13.8	10.0	15.1

1.2 Prestazioni

1.2 Performances

1.2 Leistungen

Stadio Stage Stufe	ir	$n_2 \times h$							10000 Hours Life				T_{max} [Nm]
		T_N [Nm]							n_1 [rpm]	n_2 [rpm]	T_N [Nm]	P_1 [kW]	
		10000	20000	50000	100000	500000	1000000	2000000					
2	8.85	6247	6247	6246	6245	6234	6220	5510	1400	158.19	5912	106.44	24000
	10.43	7363	7362	7361	7359	7344	6729	5465		134.23	6160	94.11	23000
	13.07	9222	9221	9219	9216	8052	6540	5313		107.12	6407	78.11	18000
	15.18	10709	9790	9685	8949	7450	6396	5196		92.23	6554	68.80	15000
	18.34	8682	8023	7228	6679	5560	5195	5092		76.34	5298	46.03	11000
	21.53	8087	8087	8087	8086	7190	6540	5313		65.03	6978	51.65	18000
	25.00	9392	9391	9391	8838	7357	6396	5196		56.00	7263	46.29	15000
	30.21	8584	7932	7146	6603	5497	5137	5034		46.34	5545	29.25	11000
	35.59	6063	5602	5047	4664	3907	3833	3687		39.34	3990	17.87	18000
	41.33	6922	6396	5762	5325	523	4424	4228		33.87	4633	17.86	15000
49.94	8185	7564	6814	6297	5440	5090	4989	28.03	5599	17.86	11000		
3	31.87	11968	11283	11282	11281	8352	6784	5510	1400	43.93	8682	44.37	24000
	37.56	13918	12807	12806	12806	8284	6729	5465		37.27	9047	39.23	23000
	44.34	13918	12807	12806	12806	8284	6729	5465		31.57	9509	34.93	23000
	55.65	13918	12807	12806	12806	8284	6729	5465		25.16	10179	29.80	23000
	64.69	13918	12807	12806	12806	8284	6729	5465		21.64	10650	26.81	23000
	73.05	13918	12807	12806	12806	8284	6729	5465		19.16	11045	24.62	23000
	78.25	13663	12626	11374	10510	8284	6729	5465		17.89	9836	20.47	23000
	91.67	13918	12807	12806	12806	8284	6729	5465		15.27	11824	21.01	23000
	106.56	13918	12807	12806	12806	8284	6729	5465		13.14	12370	18.91	23000
	120.77	13918	12807	12455	11509	8284	6729	5465		11.59	11317	15.26	23000
	133.47	11348	10354	10353	10353	8052	6540	5313		10.49	10352	12.63	18000
	151.56	13918	12807	12806	12806	8284	6729	5465		9.24	12806	13.77	23000
	176.18	13918	12807	12806	12806	8284	6729	5465		7.95	12806	11.84	23000
	213.13	13409	12391	11163	10315	8284	6729	5465		6.57	10821	8.27	23000
	266.94	11348	10354	10353	10353	8052	6540	5313		5.24	10353	6.31	18000
	310.00	10772	9790	9254	8551	7118	6396	5196		4.52	9362	4.92	15000
374.58	8334	7701	6938	6411	5337	4987	4887	3.74	7172	3.12	11000		
4	148.57	13918	12807	12806	12806	8284	6729	5465	1400	9.42	12806	14.35	23000
	182.01	13918	12807	12806	12806	8284	6729	5465		7.69	12806	11.72	23000
	214.87	13918	12807	12806	12806	8284	6729	5465		6.52	12806	9.94	23000
	263.78	13918	12807	12806	12806	8284	6729	5465		5.31	12806	8.09	23000
	290.78	13918	12807	12806	12806	8284	6729	5465		4.81	12806	7.33	23000
	319.00	13918	12807	12806	12806	8284	6729	5465		4.39	12807	6.69	23000
	364.90	13918	12807	12806	12804	8284	6729	5465		3.84	12807	5.85	23000
	390.79	13918	12807	12806	12798	8284	6729	5465		3.58	12807	5.46	23000
	421.42	13918	12807	12806	12792	8284	6729	5465		3.32	12807	5.06	23000
	455.40	13918	12807	12806	12786	8284	6729	5465		3.07	12807	4.68	23000
	512.49	13918	12807	12806	12778	8284	6729	5465		2.73	12807	4.16	23000
	587.47	13918	12807	12806	12769	8284	6729	5465		2.38	12807	3.63	23000
	660.00	13918	12807	12806	12761	8284	6729	5465		2.12	12807	3.23	23000
	767.25	13918	12807	12806	12753	8284	6729	5465		1.82	12807	2.77	23000
	870.33	13918	12807	12806	12746	8284	6729	5465		1.61	13181	2.53	23000
	1011.76	13918	12807	12806	12738	8284	6729	5465		1.38	13410	2.20	23000
	1086.17	13918	12807	12806	12734	8284	6729	5465		1.29	13519	2.08	23000
	1262.67	13918	12807	12806	12728	8284	6729	5465		1.11	13754	1.82	23000
	1360.46	11348	10354	10353	10353	8052	6540	5313		1.03	11310	1.39	18000
	1527.43	13163	12163	10958	10125	8284	6729	5465		0.92	13294	1.46	23000
	1780.22	10772	9790	9182	8485	7063	6396	5196		0.79	11073	1.04	15000
	1913.14	11348	10354	10353	10353	8052	6540	5313		0.73	11760	1.02	18000
	2221.71	10772	9790	9177	8480	7059	6396	5196		0.63	11357	0.85	15000
	2684.57	8272	7644	6886	6363	5297	4950	4851		0.52	8995	0.56	11000



P_{TN}	P	R-L-F-FC-FU FB-FCB	FS FP	T
1002	25,2	22,1	16,6	24,1
1003	18,9	16,8	13,0	18,1
1004	14,2	12,7	10,0	13,7



1.2 Prestazioni

1.2 Performances

1.2 Leistungen

EX 	n ₂ X h								10000 Hours Life	T _{max} [Nm]					
	Stadio Stage Stufe	ir	T _N [Nm]							n ₁ [rpm]	n ₂ [rpm]	T _N [Nm]	P ₁ [kW]	T _{max} [Nm]	
			10000	20000	50000	100000	500000	1000000							2000000
1	3.72	22750	21448	21447	21443	13822	11227	9119	1400	376.34	7544	306.48	41000		
	4.09	25200	23254	23253	22311	13766	11182	9082		342.30	7730	285.63	40000		
	5.25	20487	18642	18641	18182	13436	10913	8864		266.67	8131	234.07	31000		
	6.23	17390	16199	14593	13485	11226	10373	8651		224.72	8354	202.66	24000		
2	13.39	21457	20229	20228	20049	12371	10048	8162	1400	104.56	9915	115.49	41000		
	14.73	25200	23254	23253	21428	13222	10740	8723		95.04	10905	115.45	40000		
	17.39	24958	23254	23253	21118	13031	10584	8597		80.51	11296	101.31	40000		
	18.90	20487	18642	18641	17343	13436	10913	8864		74.07	11941	98.53	31000		
	22.31	20487	18642	18641	17265	13436	10913	8864		62.75	12551	87.73	31000		
	25.36	18630	18523	16687	15420	12508	10160	8252		55.21	12142	74.68	40000		
	28.00	20487	18642	18579	17168	13436	10913	8864		50.00	13436	74.84	31000		
	32.55	20487	18642	18515	17109	13436	10913	8864		43.01	14057	67.35	31000		
	39.38	17379	16060	14467	13369	12185	10913	8864		35.55	12382	49.03	31000		
	46.73	16385	15263	13750	12705	10577	9773	8651		29.96	11212	37.42	24000		
3	46.60	20748	19561	19559	16355	10092	8197	6658	1400	30.04	11758	40.20	41000		
	51.25	25200	23254	21521	17481	10786	8761	7116		27.32	12931	40.21	40000		
	60.50	24958	23254	23253	19634	12115	9840	7993		23.14	15265	40.20	40000		
	74.12	24958	23254	23253	19276	11894	9661	7847		18.89	15928	34.25	40000		
	80.57	20487	18642	18217	16834	12610	10242	8319		17.38	15807	31.27	31000		
	93.01	20920	20919	20915	19603	12642	10269	8341		15.05	18123	31.04	40000		
	100.31	23996	22174	19976	18723	11553	9384	7622		13.96	16941	26.92	40000		
	109.04	20487	18642	18144	16766	12248	9948	8081		12.84	16295	23.81	31000		
	125.87	20920	20919	20915	19481	12642	10269	8341		11.12	19246	24.36	40000		
	138.77	20487	18642	18093	16719	13436	10913	8864		10.09	16702	19.18	31000		
	161.54	20487	18642	18063	16692	13436	10913	8864		8.67	16966	16.74	31000		
	187.79	20487	18642	18037	16667	13436	10913	8864		7.46	17234	14.63	31000		
	201.60	20487	18642	18025	16656	13436	10913	8864		6.94	17363	13.71	31000		
	234.36	20487	18642	18001	16634	13436	10913	8864		5.97	17639	11.99	31000		
	283.50	16593	15333	13813	12764	11633	10913	8864		4.94	13833	7.78	31000		
	336.46	16008	14912	13433	12413	10333	9549	8651		4.16	13717	6.49	24000		
	4	178.35	25200	23254	21521	17481	10786	8761		7116	1400	7.85	18797	17.36	40000
		210.56	24958	23254	23253	19634	12115	9840		7993		6.65	22192	17.36	40000
		257.94	24958	23254	23253	19634	12115	9840		7993		5.43	23253	14.86	40000
295.68		25200	23254	21521	17481	10786	8761	7116	4.73	21876		12.17	40000		
315.99		24958	23254	23253	19276	11894	9661	7847	4.43	23253		12.12	40000		
349.06		24958	23254	23253	19634	12115	9840	7993	4.01	23253		10.97	40000		
396.53		20920	20919	20725	19151	12642	10269	8341	3.53	20917		8.69	40000		
452.05		25200	23254	21128	17161	10589	8601	6986	3.10	23254		8.48	40000		
485.28		20177	19023	19021	18035	11128	9039	7342	2.88	19022		6.45	41000		
533.67		24958	23254	23253	19276	11894	9661	7847	2.62	23254		7.17	40000		
578.69		22998	21252	19145	18355	11553	9384	7622	2.42	20796		5.92	40000		
629.07		20487	18642	17881	16523	12248	9948	8081	2.23	18642		4.89	31000		
722.20		22923	21182	19082	18295	11553	9384	7622	1.94	21257		4.85	40000		
800.57		20487	18642	17860	16504	13436	10913	8864	1.75	19218		3.96	31000		
859.45		20487	18642	17854	16498	13436	10913	8864	1.63	19374		3.72	31000		
906.29		20920	20919	20569	19007	12642	10269	8341	1.54	20919		3.79	40000		
999.11		20487	18642	17843	16488	13436	10913	8864	1.40	19711		3.25	31000		
1083.39		20487	18642	17837	16482	13436	10913	8864	1.29	19895		3.02	31000		
1163.08		20487	18642	17832	16478	13436	10913	8864	1.20	20057		2.83	31000		
1352.08		20487	18642	17822	16469	13436	10913	8864	1.04	20405		2.50	31000		
1451.52	20487	18642	17817	16464	13436	10913	8864	0.96	20572	2.32	31000				
1687.39	20487	18642	17809	16456	13436	10913	8864	0.83	20929	2.04	31000				
2041.20	16294	15057	13564	12534	11424	10797	8864	0.69	17010	1.38	31000				
2422.52	15868	14781	13315	12304	10243	9465	8651	0.58	17240	1.18	24000				

5-6 5,6 stadi/stages/stufen A richiesta / On request / Auf Anfrage

P _{tn}	P	PH	PX	R-L-F-FC-FU FB-FCB	FS FP	H HU	X	T
1501	64.9	54.7	63.5	39.6	26.7	32.7	41.5	58.1
1502	44.4	38.6	43.6	29.9	22.6	26.0	31.0	40.5
1503	28.0	22.5	27.6	19.6	15.3	17.3	20.2	25.8
1504	21.7	19.2	21.4	15.4	12.1	13.6	15.8	20.0

1.2 Prestazioni

1.2 Performances

1.2 Leistungen

		n ₂ X h								10000 Hours Life				T _{max} [Nm]
		T _N [Nm]								n ₁ [rpm]	n ₂ [rpm]	T _N [Nm]	P ₁ [kW]	
Stadio Stage Stufe	ir	10000	20000	50000	100000	500000	1000000	2000000						
2	9.41	10738	10738	10736	10734	10714	10689	9119	1400	148.78	9966	168.76	41000	
	10.35	11809	11808	11806	11803	11779	11182	9082		135.27	10213	157.24	40000	
	13.28	15154	15153	15150	15145	13436	10913	8864		105.42	10742	128.89	31000	
	15.76	16813	15661	14109	13037	10853	10029	8651		88.83	10165	102.77	24000	
	21.88	13994	13992	13988	13980	11939	10913	8864		63.99	11608	84.54	31000	
	25.96	16589	15452	13921	12863	10708	9895	8651		53.93	10616	65.16	24000	
	36.17	9500	8779	7908	7308	6131	6013	5781		38.71	6263	27.59	31000	
	42.92	11057	10217	9204	8505	7250	7084	6759		32.62	7433	27.60	24000	
3	33.87	17249	17246	17238	17223	12371	10048	8162	1400	41.33	13098	62.98	41000	
	37.25	18969	18965	18955	18938	13222	10740	8723		37.58	14404	62.98	40000	
	43.98	22393	22388	22374	21118	13031	10584	8597		31.83	14921	55.26	40000	
	55.19	20920	20919	20915	19862	12642	10269	8341		25.37	15497	45.74	40000	
	64.16	18630	17983	16200	14970	12508	10160	8252		21.82	13697	34.77	40000	
	72.44	19439	19437	19275	17811	13031	10584	8597		19.33	16523	37.16	40000	
	82.33	20487	18642	18211	16828	13436	10913	8864		17.00	15841	31.33	31000	
	90.91	20920	20919	20915	19613	12642	10269	8341		15.40	18000	32.25	40000	
	105.68	18630	17776	16014	14798	12508	10160	8252		13.25	14331	22.09	40000	
	116.67	20487	18642	18129	16752	13436	10913	8864		12.00	16408	22.91	31000	
	135.63	20487	18642	18097	16723	13436	10913	8864		10.32	16663	20.01	31000	
	153.71	18526	17119	15422	14251	13227	10913	8864		9.11	14403	15.27	31000	
	174.73	18630	17613	15867	14662	12508	10160	8252		8.01	15037	14.01	40000	
	192.89	20487	18642	18032	16663	13436	10913	8864		7.26	17282	14.60	31000	
	224.23	20487	18642	18008	16640	13436	10913	8864		6.24	17558	12.75	31000	
	271.25	16604	15343	13822	12772	11641	10913	8864		5.16	13772	8.27	31000	
321.92	16013	14916	13438	12417	10337	9552	8651	4.35	13653	6.91	24000			
4	147.35	25200	23254	21521	17481	10786	8761	7116	1400	9.50	17751	20.07	40000	
	173.95	24958	23254	23253	19634	12115	9840	7993		8.05	20956	20.07	40000	
	213.10	24958	23254	23253	19276	11894	9661	7847		6.57	21865	17.09	40000	
	252.10	24958	23254	23162	19634	12115	9840	7993		5.55	22886	15.11	40000	
	288.38	23299	21530	19395	18595	11553	9384	7622		4.85	19461	11.23	40000	
	308.84	24958	23254	23253	19276	11894	9661	7847		4.53	23253	12.53	40000	
	361.89	20920	20919	20746	19171	12642	10269	8341		3.87	20917	9.63	40000	
	387.56	20920	20919	20730	19156	12642	10269	8341		3.61	20917	8.99	40000	
	417.94	23126	21370	19252	18457	11553	9384	7622		3.35	20150	8.03	40000	
	464.42	20487	18642	17912	16552	13436	10913	8864		3.01	18641	6.68	31000	
	524.48	20920	20919	20665	19095	12642	10269	8341		2.67	20918	6.65	40000	
	579.60	20487	18642	17889	16531	13436	10913	8864		2.42	18641	5.37	31000	
	637.81	20272	18732	17876	17268	12642	10269	8341		2.20	18535	4.85	40000	
	687.81	21674	20028	19095	18307	11553	9384	7622		2.04	19988	4.85	40000	
	782.45	20487	18642	17862	16506	13436	10913	8864		1.79	19167	4.08	31000	
	863.14	20920	20919	20576	19014	12642	10269	8341		1.62	20919	4.03	40000	
	976.50	20487	18642	17844	16489	13436	10913	8864		1.43	19659	3.35	31000	
	1107.69	20487	18642	17835	16481	13436	10913	8864		1.26	19945	2.99	31000	
	1287.69	20487	18642	17825	16471	13436	10913	8864		1.09	20292	2.63	31000	
	1382.40	20487	18642	17820	16467	13436	10913	8864		1.01	20457	2.46	31000	
	1607.04	20487	18642	17811	16459	13436	10913	8864		0.87	20813	2.15	31000	
	1907.26	15878	14791	13324	12312	10250	9471	8651		0.73	16638	1.45	24000	
	2307.16	15870	14783	13317	12306	10244	9466	8651		0.61	17115	1.24	24000	



P _{TN}	P	PH	PX	R-L-F-FC-FU FB-FCB	FS FP	H HU	X	T
1502	41.2	37.5	40.7	32.0	27.3	29.5	32.7	38.8
1503	26.8	22.7	26.5	20.5	17.2	18.7	20.9	25.1
1504	20.0	18.1	19.7	15.4	13.0	14.1	15.7	18.7



1.2 Prestazioni

1.2 Performances

1.2 Leistungen

EX		n ₂ X h								10000 Hours Life				T _{max} [Nm]	
Stadio Stage Stufe	ir	T _N [Nm]								n ₁ [rpm]	n ₂ [rpm]	T _N [Nm]	P ₁ [kW]		
		10000	20000	50000	100000	500000	1000000	2000000							
2	15.84	27664	25403	25340	22549	13914	11301	9180	1400	88.38	11728	115.46	41000		
	18.90	23930	21774	21012	19416	15745	12789	10388		74.07	13993	115.46	39000		
	22.31	23930	21774	20918	19329	15517	12604	10237		62.75	14495	101.32	39000		
	28.00	23930	21774	20800	19221	15054	12228	9932		50.00	15054	83.85	39000		
	32.55	23908	21774	20729	19155	14895	12098	9827		43.01	15583	74.66	39000		
	39.38	17379	16060	14467	13369	12185	11516	9710		35.55	12382	49.03	39000		
3	55.12	27664	25403	22647	18395	11350	9219	7488	1400	25.40	13908	40.21	41000		
	65.08	26844	25403	24532	20661	12749	10355	8411		21.51	16419	40.20	41000		
	79.72	26844	25403	24455	20284	12516	10166	8257		17.56	17131	34.24	41000		
	100.04	22500	22499	22495	20910	13304	10806	8777		13.99	19493	31.04	41000		
	107.88	25596	23652	21308	19703	12157	9875	8021		12.98	18221	26.92	41000		
	119.37	23930	21774	20291	18750	15054	12228	9932		11.73	18412	24.58	39000		
	135.38	22500	22499	22487	20779	13304	10806	8777		10.34	20700	24.36	41000		
	161.54	23930	21774	20223	18687	15054	12228	9932		8.67	18995	18.74	39000		
	187.79	23847	21774	19851	18344	14895	12098	9827		7.46	18968	16.11	39000		
	201.60	23750	21774	20180	18647	15054	12228	9932		6.94	19438	15.35	39000		
	234.36	23758	21774	19777	18275	14895	12098	9827		5.97	19380	13.17	39000		
	283.50	16593	15333	13813	12764	11633	10995	9710		4.94	13833	7.78	39000		
	4	191.83	21051	20763	20284	16476	10166	8258		6707	1400	7.30	20218	17.36	41000
		226.46	21504	21208	18059	14669	9051	7352		5972		6.18	23584	17.15	41000
277.43		22948	21636	21220	18644	11504	9344	7590	5.05	24095		14.32	41000		
318.02		22948	21636	20063	16296	10055	8167	6634	4.40	23529		12.18	41000		
339.86		20333	17239	16020	13988	8631	7011	5694	4.12	24621		11.93	41000		
389.59		22948	21636	21220	18304	11294	9174	7451	3.59	24549		10.37	41000		
459.93		22948	21636	20063	16296	10055	8167	6634	3.04	25403		9.09	41000		
486.20		22869	21636	21220	19636	12116	9841	7994	2.88	25403		8.61	41000		
548.78		22948	21636	21220	17779	10970	8911	7238	2.55	21630		6.49	39000		
573.99		22948	21636	20063	16296	10055	8167	6634	2.44	25403		7.29	41000		
622.41		22869	21636	21220	19636	12116	9841	7994	2.25	22367		5.92	41000		
720.30		22869	21636	21220	19636	12116	9841	7994	1.94	22499		5.14	41000		
800.57		22948	21636	20063	16296	10055	8167	6634	1.75	21965		4.52	39000		
859.45		21437	20280	18847	15829	9767	7933	6444	1.63	22630		4.34	39000		
926.83		22869	21636	21220	19636	12116	9841	7994	1.51	22826		4.06	39000		
999.11		22948	21636	21220	17779	10970	8911	7238	1.40	22485		3.70	39000		
1083.39		19475	19195	16711	15947	11988	9737	7909	1.29	22680		3.44	39000		
1163.08		22869	21636	21220	19636	12116	9841	7994	1.20	23427		3.31	39000		
1352.08		22948	21636	21220	17779	10970	8911	7238	1.04	23222		2.84	39000		
1451.52		19475	19195	16711	15947	11988	9737	7909	0.96	22899		2.59	39000		
1687.39		22869	21636	21220	19636	12116	9841	7994	0.83	23782		2.32	39000		
2041.20		19475	19195	16711	15947	11988	9737	7909	0.69	17010		1.38	39000		

5-6

5,6 stadi/stages/stufen
A richiesta / On request / Auf Anfrage

P _{TN}	P	PH	PX	R-L-F-FC-FU FB-FCB	FS FP	H HU	X	T
1802	44.4	38.6	43.6	29.9	22.6	26.0	31.0	40.5
1803	28.0	22.5	27.6	19.6	15.3	17.3	20.2	25.8
1804	21.7	19.2	21.4	15.4	12.1	13.6	15.8	20.0

1.2 Prestazioni

1.2 Performances

1.2 Leistungen

EXB		n ₂ X h								10000 Hours Life				T _{max} [Nm]
Stadio Stage Stufe	ir	T _N [Nm]								n ₁ [rpm]	n ₂ [rpm]	T _N [Nm]	P ₁ [kW]	
		10000	20000	50000	100000	500000	1000000	2000000						
3	40.07	20402	20398	20386	20366	13914	11301	9180	1400	34.94	15493	62.98	41000	
	47.30	24084	24079	24062	22223	13712	11138	9047						
	56.44	23930	21774	20509	18951	15517	12604	10237						
	59.36	22500	22499	22495	21186	13304	10806	8777						
	70.82	23930	21774	20434	18882	15054	12228	9932						
	77.92	20908	20906	20560	18998	13712	11138	9047						
	82.33	23908	21774	20208	18673	14895	12098	9827						
	92.97	23930	21774	20355	18809	15517	12604	10237						
	97.78	22500	22499	22495	20921	13304	10806	8777						
	116.67	23930	21774	20296	18755	15054	12228	9932						
	135.63	23908	21774	19975	18458	14895	12098	9827						
	161.66	19373	17902	16127	14902	13304	10806	8777						
	192.89	22655	20934	18859	17670	15054	12228	9932						
	224.23	23775	21774	19791	18289	14895	12098	9827						
	271.25	16604	15343	13822	12772	11641	11002	9710						
	4	158.48	27622	25403	22647	18395	11350	9219						7488
187.09		26844	25403	24205	20661	12749	10355	8411						
229.20		26844	25403	24159	20284	12516	10166	8257						
271.15		26844	25403	24125	20661	12749	10355	8411						
332.17		26844	25403	24087	20284	12516	10166	8257						
370.09		23930	21774	20083	18558	13757	11174	9076						
398.95		23581	21774	19630	18139	14895	12098	9827						
416.84		22500	22499	22112	20433	13304	10806	8777						
449.52		24668	22795	20535	19703	12157	9875	8021						
497.37		23930	21774	20045	18523	15054	12228	9932						
536.36		23930	21774	20037	18515	13757	11174	9076						
564.10		22500	22499	22042	20368	13304	10806	8777						
673.08		23930	21774	20012	18493	15054	12228	9932						
782.45		23414	21636	19491	18011	14895	12098	9827						
882.69		23930	21774	19987	18469	13757	11174	9076						
928.35		22500	22499	21948	20281	13304	10806	8777						
976.50		23371	21596	19455	17978	14895	12098	9827						
1107.69		23930	21774	19968	18451	15054	12228	9932						
1287.69		23323	21552	19415	17941	14895	12098	9827						
1382.40		22819	21086	19787	18436	15054	12228	9932						
1607.04		23289	21520	19387	17915	14895	12098	9827						
1944.00		16299	15061	13568	12538	11427	10800	9710						



P _{TN}	P	PH	PX	R-L-F-FC-FU FB-FCB	FS FP	H HU	X	T
1803	26,8	22,7	26,5	20,5	17,2	18,7	20,9	25,1
1804	20,0	18,1	19,7	15,4	13,0	14,1	15,7	18,7

1.2 Prestazioni

1.2 Performances

1.2 Leistungen

EX		n ₂ X h							10000 Hours Life				T _{max} [Nm]																
Stadio Stage Stufe	ir	T _N [Nm]							n ₁ [rpm]	n ₂ [rpm]	T _N [Nm]	P ₁ [kW]																	
		10000	20000	50000	100000	500000	1000000	2000000																					
1	4.40	27664	25403	25402	24650	18203	14786	12010	1400	318.18	10448	358.86	41000																
	5.25	23930	21774	21774	20356	16946	14551	11819						266.67	10842	312.11	39000												
2	15.84	27664	25403	25340	23416	18203	14786	12010	1400	88.38	15344	151.06	41000																
	18.90	23930	21774	21012	19416	16163	14551	11819						74.07	15455	127.52	39000												
	20.00	27664	25403	25167	23256	18111	14711	11949										70.00	16372	127.66	41000								
	23.47	26252	25403	25058	23155	17738	14408	11703														59.65	16824	111.79	41000				
	28.00	23930	21774	20800	19221	16000	14551	11819																		50.00	16000	89.12	39000
	55.12	27664	25403	24601	22733	15134	12292	9985																					
69.60	27664	25403	24506	22645	17817	14472	11755																						
81.66	26252	25403	24446	22590	17738	14408	11703																						
85.26	27664	25403	24431	22576	17492	14208	11540																						
91.38	25809	23849	21485	20940	14431	11722	9521																						
100.04	26252	25403	24378	22526	17738	14408	11703																						
115.38	27664	25403	24333	22486	16990	13800	11209																						
135.38	26252	25403	24287	22443	17738	14408	11703																						
161.54	23930	21774	20223	18687	15556	14402	11819																						
191.83	27664	25403	24199	22361	14616	11872	9643																						
242.21	27664	25403	24148	22314	17207	13977	11353																						
287.88	27664	25403	24113	22282	14857	12068	9802																						
318.02	27664	25403	24095	22265	13938	11321	9195																						
348.15	26252	25403	24079	22250	17738	14408	11703																						
389.59	27664	25403	24060	22233	14857	12068	9802																						
426.50	26252	25403	24045	22220	17738	14408	11703																						
486.20	27238	25403	24026	22201	14857	12068	9802																						
501.12	27664	25403	24021	22197	16187	13148	10679																						
577.17	26252	25403	24002	22179	17738	14408	11703																						
613.89	27664	25403	23994	22172	17492	14208	11540																						
720.30	26252	25403	23974	22153	17738	14408	11703																						
830.77	27664	25403	23957	22138	16990	13800	11209																						
974.77	26252	25403	23940	22122	17738	14408	11703																						
1163.08	23930	21774	19964	18448	15357	14218	11819																						

5-6

5,6 stadi/stages/stufen
A richiesta / On request / Auf Anfrage

P _{TN}	P	PH	PX	R-L-F-FC-FU FB-FCB	FS FP	H HU	X	T
2001	64.9	54.7	63.5	39.6	26.7	32.7	41.5	58.1
2002	44.4	38.6	43.6	29.9	22.6	26.0	31.0	40.5
2003	28.0	22.5	27.6	19.6	15.3	17.3	20.2	25.8
2004	21.7	19.2	21.4	15.4	12.1	13.6	15.8	20.0

1.2 Prestazioni

1.2 Performances

1.2 Leistungen

		n ₂ X h							10000 Hours Life				T _{max} [Nm]
		T _N [Nm]							n ₁ [rpm]	n ₂ [rpm]	T _N [Nm]	P ₁ [kW]	
Stadio Stage Stufe	ir	10000	20000	50000	100000	500000	1000000	2000000					
2	11.13	12701	12700	12698	12695	12667	12632	12010	1400	125.79	12615	180.61	41000
	13.28	15154	15153	15150	15145	15106	14551	11819		105.42	14322	171.84	39000
	18.33	11728	11727	11724	11719	10210	9520	9335		76.38	9728	84.57	41000
	21.88	13994	13992	13988	13980	11939	11316	11053		63.99	11608	84.54	39000
	30.31	8124	7507	6763	6249	5202	5071	4907		46.19	5249	27.60	41000
	36.17	9500	8779	7908	7308	6131	6013	5781		38.71	6263	27.59	39000
3	40.07	20402	20398	20386	20366	18203	14786	12010	1400	34.94	19832	80.62	41000
	50.59	25758	25403	24639	22768	18111	14711	11949		27.67	20275	65.27	41000
	59.36	26252	25403	24569	22704	17738	14408	11703		23.58	20589	56.49	41000
	70.82	23930	21774	20434	18882	15719	14551	11819		19.77	17472	40.19	39000
	78.75	21131	21129	20402	18853	15694	14530	11819		17.78	17656	36.52	39000
	83.33	22361	22359	21821	20164	18111	14711	11949		16.80	19007	37.15	41000
	97.78	26237	25403	24385	22533	17738	14408	11703		14.32	21630	36.04	41000
	116.67	23930	21774	20296	18755	15613	14454	11819		12.00	18369	25.65	39000
	137.78	16814	15537	13997	12934	11961	11073	10713		10.16	12911	15.26	41000
	161.66	19373	17902	16127	14902	13850	12640	11703		8.66	15148	15.26	41000
4	192.89	22655	20934	18859	17670	15529	14377	11819	1400	7.26	18075	15.27	39000
	158.48	27622	25403	24245	22404	15134	12292	9985		8.83	22723	23.87	41000
	200.10	27664	25403	24189	22352	17817	14472	11755		7.00	23281	19.39	41000
	245.13	27664	25403	24145	22311	17492	14208	11540		5.71	23782	16.16	41000
	281.37	27664	25403	24118	22286	14857	12068	9802		4.98	24131	14.30	41000
	331.73	27664	25403	24087	22258	16990	13800	11209		4.22	24557	12.33	41000
	389.23	26252	25403	24060	22233	17738	14408	11703		3.60	24980	10.70	41000
	416.84	26252	25403	24049	22223	17738	14408	11703		3.36	25165	10.06	41000
	464.42	23930	21774	20054	18531	15426	14282	11819		3.01	21244	7.61	39000
	480.77	27664	25403	24027	22203	16990	13800	11209		2.91	25403	8.80	41000
	564.10	26252	25403	24005	22182	17738	14408	11703		2.48	25403	7.50	41000
	673.08	23930	21774	20012	18493	15394	14252	11819		2.08	21774	5.39	39000
	791.21	24537	22674	21993	21062	16990	13800	11209		1.77	22993	4.84	41000
	928.35	26252	25403	23945	22127	17738	14408	11703		1.51	26251	4.72	41000
	1107.69	23930	21774	19968	18451	15360	14220	11819		1.26	23297	3.49	39000

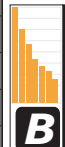

P _{TN}	P	PH	PX	R-L-F-FC-FU FB-FCB	FS FP	H HU	X	T
2002	41.2	37.5	40.7	32.0	27.3	29.5	32.7	38.8
2003	26.8	22.7	26.5	20.5	17.2	18.7	20.9	25.1
2004	20.0	18.1	19.7	15.4	13.0	14.1	15.7	18.7



1.2 Prestazioni

1.2 Performances

1.2 Leistungen

EX 	n ₂ X h								10000 Hours Life				T _{max} [Nm]		
	Stadio Stage Stufe	ir	T _N [Nm]								n ₁ [rpm]	n ₂ [rpm]		T _N [Nm]	P ₁ [kW]
10000			20000	50000	100000	500000	1000000	2000000	10000	20000			50000		
1	3.63	31472	29425	29424	29421	20752	16856	13691	1400	385.67	11243	468.08	63000		
	4.00	37274	35141	35138	33133	20444	16606	13488		350.00	11404	430.87	64000		
	5.20	33401	30405	30404	30045	20143	16362	13290		269.23	12156	353.30	57000		
	6.25	29044	26316	24822	22937	19094	16050	13036		224.00	12601	304.70	39000		
2	12.69	30333	29425	29424	23958	14783	12008	9753	1400	110.32	11659	143.28	63000		
	14.00	33471	33125	31600	25667	15838	12864	10449		100.00	12864	143.30	64000		
	16.50	34931	32933	31344	25459	15709	12760	10364		84.85	13404	126.69	64000		
	18.20	33401	30405	30404	28599	19030	15458	12555		76.92	16723	143.29	57000		
	21.45	33401	30405	30404	28462	18876	15332	12453		65.27	17426	126.70	57000		
	26.87	33401	30405	30404	28289	18348	14903	12105		52.10	18123	105.18	57000		
	31.20	33401	30405	30404	28184	17944	14575	11839		44.87	18536	92.65	57000		
	37.70	26780	24747	22293	20600	17776	14439	11728		37.14	18977	78.51	57000		
	45.31	27784	25884	23318	21547	17937	16050	13036		30.90	18948	65.22	39000		
	50.40	31655	31652	31600	25667	15838	12864	10449		27.78	18892	59.73	64000		
3	59.40	33787	31854	31344	25459	15709	12760	10364	1400	23.57	19685	52.81	64000		
	65.52	33401	30405	30044	27762	19030	15458	12555		21.37	24559	59.73	57000		
	70.13	33684	31757	31344	25459	15709	12760	10364		19.96	20691	47.01	64000		
	77.35	33401	30405	29962	27687	19030	15458	12555		18.10	25813	53.18	57000		
	91.16	33401	30405	29888	27618	18876	15332	12453		15.36	26301	45.98	57000		
	102.30	33480	31565	29587	25459	15709	12760	10364		13.69	23172	36.11	64000		
	114.18	33401	30405	29796	27533	18348	14903	12105		12.26	26901	37.54	57000		
	132.60	33401	30405	29740	27481	17944	14575	11839		10.56	27312	32.83	57000		
	143.29	33401	30405	29712	27456	18348	14903	12105		9.77	27529	30.61	57000		
	166.57	33401	30405	29662	27410	18348	14903	12105		8.40	27958	26.73	57000		
	201.50	33401	30405	29604	27356	18348	14903	12105		6.95	28515	22.56	57000		
	234.00	33401	30405	29562	27317	17944	14575	11839		5.98	28963	19.71	57000		
	281.25	27120	25266	22761	21033	17509	16050	13036		4.98	22773	12.91	39000		
	339.84	27080	25229	22727	21002	17483	16050	13036		4.12	23235	10.90	39000		
	4	175.39	30668	30665	27390	22248	13727	11150		9057	1400	7.98	23804	22.35	64000
		206.71	33190	31291	30728	24959	15401	12509		10161		6.77	28054	22.35	64000
244.04		33135	31239	31236	25459	15709	12760	10364	5.74	30077		20.31	64000		
298.95		33073	31181	31178	25459	15709	12760	10364	4.68	31178		17.17	64000		
317.25		33401	30405	29485	27246	18876	15332	12453	4.41	29908		15.52	57000		
342.69		33035	31145	29302	23801	14686	11929	9689	4.09	31133		14.98	64000		
404.57		32993	31105	31102	25459	15709	12760	10364	3.46	31104		12.66	64000		
445.50		33401	30405	29412	27179	17647	14334	11642	3.14	30405		11.23	57000		
507.69		32940	31055	31052	25459	15709	12760	10364	2.76	31054		10.08	64000		
558.00		33401	30405	29371	27140	18348	14903	12105	2.51	30405		8.98	57000		
633.60		32894	31012	31009	25459	15709	12760	10364	2.21	31011		8.06	64000		
698.88		33401	30405	29333	27106	19030	15458	12555	2.00	30405		7.15	57000		
736.56		32865	30985	28113	25459	15709	12760	10364	1.90	30985		6.93	64000		
823.68		33401	30405	29309	27083	18876	15332	12453	1.70	31434		6.29	57000		
961.00		33401	30405	29287	27063	18348	14903	12105	1.46	31994		5.50	57000		
1031.68		33401	30405	29278	27054	18348	14903	12105	1.36	32255		5.16	57000		
1162.50		33401	30405	29263	27041	18348	14903	12105	1.20	32698		4.62	57000		
1350.00		33401	30405	29113	26902	17944	14575	11839	1.04	33263		4.07	57000		
1450.80		33401	30405	29237	27017	18348	14903	12105	0.96	33538		3.79	57000		
1684.80		33401	30405	29069	26861	17944	14575	11839	0.83	34117		3.33	57000		
2025.00		26841	25006	22527	20816	17328	16012	13036	0.69	28382		2.30	39000		
2446.88		26826	24992	22514	20804	17319	16004	13036	0.57	29190		1.96	39000		

5-6 5,6 stadi/stages/stufen
A richiesta / On request / Auf Anfrage

P _{TN}	PH	FCB	FS FP	H HU	T
2501	61.8	41.8	33.4	36.6	57.1
2502	45.4	34.0	29.2	31.0	42.7
2503	26.5	22.5	19.7	20.8	27.6
2504	22.5	17.5	15.4	16.2	21.4

1.2 Prestazioni

1.2 Performances

1.2 Leistungen

Stadio Stage Stufe	ir	$n_2 \times h$							10000 Hours Life				T_{max} [Nm]
		T_N [Nm]							n_1 [rpm]	n_2 [rpm]	T_N [Nm]	P_1 [kW]	
		10000	20000	50000	100000	500000	1000000	2000000					
2	9.17	15625	15625	15622	15619	15591	15556	13691	1400	152.67	14846	257.97	63000
	10.12	17242	17241	17238	17234	17200	16606	13488		138.34	15065	237.21	64000
	13.15	22414	22412	22408	22401	20143	16362	13290		106.46	16057	194.56	57000
	15.81	26939	26316	23952	22133	18425	16050	13036		88.55	16646	167.77	39000
	21.67	19764	19763	19762	19759	17788	16362	13290		64.61	17276	127.04	57000
	26.04	23754	23754	23612	21819	18163	16050	13036		53.76	18014	110.22	39000
	35.82	14485	13385	12058	11143	9340	9162	8811		39.08	9540	42.43	57000
	43.06	17049	15755	14193	13115	11182	10926	10422		32.51	11466	42.43	39000
3	32.09	22303	22300	22289	22272	14783	12008	9753	1400	43.63	15400	78.17	63000
	35.41	24610	24606	24593	24572	15838	12864	10449		39.54	16993	78.17	64000
	46.04	31992	30405	30240	27944	19030	15458	12555		30.41	22092	78.16	57000
	54.26	33401	30405	30145	27855	18876	15332	12453		25.80	23020	69.10	57000
	67.96	33401	30405	30025	27745	18348	14903	12105		20.60	23940	57.38	57000
	78.92	33401	30405	29953	27678	17944	14575	11839		17.74	24487	50.54	57000
	89.38	33069	30405	29897	27626	18876	15332	12453		15.66	26249	47.83	57000
	95.36	33401	30405	29869	27601	17944	14575	11839		14.68	25917	44.27	57000
	111.94	33401	30405	29803	27540	18348	14903	12105		12.51	26847	39.08	57000
	130.00	33401	30405	29747	27488	17944	14575	11839		10.77	27257	34.15	57000
	157.08	33401	30405	29681	27427	17944	14575	11839		8.91	27789	28.81	57000
	185.08	25736	23781	21424	19995	18348	14903	12105		7.56	20437	17.98	57000
	214.93	29382	27151	24459	23146	17944	14575	11839		6.51	23733	17.98	57000
	259.71	29210	26992	24316	23011	17944	14575	11839		5.39	24109	15.12	57000
	312.15	27097	25245	22742	21015	17494	16050	13036		4.49	23026	12.03	39000
	4	144.90	25256	25249	25202	25113	15838	12864		10449	1400	9.66	25119
170.78		29764	29756	29684	25459	15709	12760	10364	8.20	27023		26.37	64000
201.61		33198	31299	31296	25459	15709	12760	10364	6.94	28402		23.45	64000
222.38		33401	30405	29576	27330	19030	15458	12555	6.30	28809		21.60	57000
253.00		33123	31228	31225	25459	15709	12760	10364	5.53	30404		20.01	64000
294.11		33078	31185	28633	25459	15709	12760	10364	4.76	28794		16.31	64000
328.28		33401	30405	29477	27239	18348	14903	12105	4.26	30016		15.22	57000
366.67		33018	31128	31126	25459	15709	12760	10364	3.82	31127		14.15	64000
381.23		33401	30405	29444	27208	17944	14575	11839	3.67	30405		13.28	57000
411.96		33401	30405	29428	27193	18348	14903	12105	3.40	30405		12.30	57000
459.26		30499	30497	29263	24747	15270	12403	10074	3.05	30496		11.07	64000
478.90		33401	30405	29399	27166	18348	14903	12105	2.92	30405		10.56	57000
552.50		33401	30405	29352	27123	17944	14575	11839	2.53	30405		9.15	57000
645.83		30285	27985	25666	24747	15270	12403	10074	2.17	27730		7.16	64000
694.06		33401	30405	29334	27107	18348	14903	12105	2.02	30405		7.31	57000
750.00		27790	25679	23134	21377	14934	12130	9852	1.87	25882		5.76	64000
839.58		33401	30405	29306	27080	18348	14903	12105	1.67	31503		6.26	57000
975.00		33401	30405	29188	26971	17944	14575	11839	1.44	32047		5.49	57000
1142.22		33401	30405	29265	27043	18348	14903	12105	1.23	32632		4.78	57000
1381.71		33401	30405	29243	27022	18348	14903	12105	1.01	33351		4.01	57000
1604.57		33401	30405	29078	26870	17944	14575	11839	0.87	33927		3.51	57000
1928.57		26845	25009	22530	20819	17331	16015	13036	0.73	28177		2.45	39000
2330.36		26829	24995	22517	20807	17321	16006	13036	0.60	28979		2.07	39000



P_{TN}	PH	FCB	FS FP	H HU	T
2502	41.9	34.6	31.5	32.7	40.2
2503	25.6	22.6	20.5	21.3	26.5
2504	20.6	16.9	15.4	16.0	19.7



1.2 Prestazioni

1.2 Performances

1.2 Leistungen

EX		$n_2 \times h$							10000 Hours Life				T_{max} [Nm]
Stadio Stage Stufe	ir	T_N [Nm]							n_1 [rpm]	n_2 [rpm]	T_N [Nm]	P_1 [kW]	
		10000	20000	50000	100000	500000	1000000	2000000					
2	12.69	31472	29425	29424	29421	20264	16460	13369	1400	110.32	15981	196.39	63000
	14.00	35135	33125	33122	33117	20444	16606	13488		100.00	16606	184.98	64000
	16.50	34931	32933	32930	32925	20444	16606	13488		84.85	17445	164.89	64000
	18.20	33401	30405	30404	28599	20143	16362	13290		76.92	17701	151.67	57000
	20.67	34676	32692	32689	32684	20444	16606	13488		67.73	18665	140.82	64000
	26.87	33401	30405	30404	28289	20143	16362	13290		52.10	19896	115.47	57000
	31.20	33401	30405	30404	28184	20143	16362	13290		44.87	20808	104.01	57000
	37.70	33401	30405	30368	28062	20143	16362	13290		37.14	22024	91.12	57000
	45.31	27784	25884	23318	21547	17937	16050	13036		30.90	18948	65.22	39000
3	45.68	31472	29425	29424	29421	20264	16460	13369	1400	30.65	23469	81.87	63000
	50.40	33897	31957	31955	31950	20444	16606	13488		27.78	24387	77.11	64000
	59.40	33787	31854	31851	31846	20444	16606	13488		23.57	25619	68.73	64000
	70.13	33684	31757	31754	31750	20444	16606	13488		19.96	26928	61.17	64000
	77.35	33401	30405	29962	27687	20143	16362	13290		18.10	25877	53.31	57000
	87.83	33558	31638	31635	31631	20444	16606	13488		15.94	28808	52.26	64000
	102.30	33480	31565	31562	31557	20444	16606	13488		13.69	30157	46.99	64000
	114.18	33401	30405	29796	27533	20143	16362	13290		12.26	26901	37.54	57000
	128.13	33376	31466	31464	31459	20444	16606	13488		10.93	31458	39.13	64000
	148.80	33313	31407	31404	29491	20444	16606	13488		9.41	29697	31.81	64000
	166.57	33401	30405	29662	27410	20143	16362	13290		8.40	27958	26.73	57000
	201.50	33401	30405	29604	27356	20143	16362	13290		6.95	28515	22.56	57000
	234.00	33401	30405	29562	27317	20143	16362	13290		5.98	28963	19.71	57000
	282.75	33401	30405	29513	27272	20143	16362	13290		4.95	29546	16.65	57000
	339.84	27080	25229	22727	21002	17483	16050	13036		4.12	23235	10.90	39000
4	175.39	33249	31346	31343	31339	20444	16606	13488	1400	7.98	31341	29.43	64000
	206.71	33190	31291	31288	31283	20444	16606	13488		6.77	31286	24.92	64000
	244.04	33135	31239	31236	31231	20444	16606	13488		5.74	31235	21.09	64000
	298.95	33073	31181	31178	31174	20444	16606	13488		4.68	31178	17.17	64000
	317.18	33057	31165	31162	31158	20444	16606	13488		4.41	31163	16.17	64000
	342.69	33035	31145	31142	31138	20444	16606	13488		4.09	31143	14.99	64000
	404.57	32993	31105	31102	31098	20444	16606	13488		3.46	31104	12.66	64000
	445.90	32969	31083	31080	31076	20444	16606	13488		3.14	31082	11.48	64000
	507.69	32940	31055	31052	31048	20444	16606	13488		2.76	31054	10.08	64000
	558.00	33401	30405	29371	27140	20143	16362	13290		2.51	30405	8.98	57000
	633.60	32894	31012	31009	31004	20444	16606	13488		2.21	31011	8.06	64000
	698.88	33401	30405	29333	27106	20143	16362	13290		2.00	30405	7.15	57000
	736.56	32865	30985	30982	30977	20444	16606	13488		1.90	30985	6.93	64000
	823.68	33401	30405	29309	27083	20143	16362	13290		1.70	31434	6.29	57000
	961.00	33401	30405	29287	27063	20143	16362	13290		1.46	31994	5.50	57000
	1031.68	33401	30405	29278	27054	20143	16362	13290		1.36	32255	5.16	57000
	1162.50	33401	30405	29263	27041	20143	16362	13290		1.20	32698	4.62	57000
	1350.00	33401	30405	29245	27025	20143	16362	13290		1.04	33263	4.07	57000
	1450.80	33401	30405	29237	27017	20143	16362	13290		0.96	33538	3.79	57000
	1684.80	33401	30405	29222	27003	20143	16362	13290		0.83	34117	3.33	57000
	2035.80	33401	30405	29204	26986	20143	16362	13290		0.69	34864	2.83	57000
2446.88	26826	24992	22514	20804	17319	16004	13036	0.57	29190	1.96	39000		

5-6

5,6 stadi/stages/stufen
A richiesta / On request / Auf Anfrage

P_{TN}	PH	FCB	FS FP	H HU	T
2802	46.3	34.9	30.1	31.9	43.6
2803	27.0	23.5	20.7	21.7	28.6
2804	23.3	18.3	16.2	17.0	22.1

1.2 Prestazioni

1.2 Performances

1.2 Leistungen

		n ₂ X h							10000 Hours Life				T _{max} [Nm]
		T _N [Nm]							n ₁ [rpm]	n ₂ [rpm]	T _N [Nm]	P ₁ [kW]	
Stadio Stage Stufe	ir	10000	20000	50000	100000	500000	1000000	2000000					
3	32.09	22303	22300	22289	22272	20264	16460	13369	1400	43.63	21110	107.16	63000
	35.41	24610	24606	24593	24572	20444	16606	13488		39.54	21936	100.91	64000
	46.04	31992	30405	30240	27944	20143	16362	13290		30.41	23384	82.74	57000
	52.27	33872	31934	31931	31926	20444	16606	13488		26.78	24655	76.82	64000
	60.71	33773	31840	31838	30109	20444	16606	13488		23.06	25787	69.19	64000
	67.96	33401	30405	30025	27745	20143	16362	13290		20.60	25552	61.24	57000
	73.35	33658	31732	31729	29956	20444	16606	13488		19.09	27293	60.62	64000
	86.11	31862	31648	31448	29059	20444	16606	13488		16.26	27494	52.01	64000
	100.00	33492	31575	31573	29733	20444	16606	13488		14.00	28614	46.61	64000
	111.94	33401	30405	29803	27540	20143	16362	13290		12.51	26847	39.08	57000
	120.83	33402	31491	31488	29612	20444	16606	13488		11.59	29119	39.27	64000
	130.00	33401	30405	29747	27488	20143	16362	13290		10.77	27257	34.15	57000
	157.08	33401	30405	29681	27427	20143	16362	13290		8.91	27789	28.81	57000
	185.08	25736	23781	21424	19995	18444	16362	13290		7.56	20437	17.98	57000
	214.93	29382	27151	24459	23146	20143	16362	13290		6.51	23733	17.98	57000
	259.71	29210	26992	24316	23011	20143	16362	13290		5.39	24109	15.12	57000
	312.15	27097	25245	22742	21015	17494	16050	13036		4.49	23026	12.03	39000
4	127.48	33378	31468	31466	31461	20444	16606	13488	1400	10.98	31460	41.10	64000
	150.25	33309	31403	31400	31396	20444	16606	13488		9.32	31396	34.82	64000
	177.38	33244	31342	31340	31335	20444	16606	13488		7.89	31337	29.42	64000
	222.17	33165	31267	31265	31260	20444	16606	13488		6.30	31264	23.44	64000
	258.76	33116	31221	31219	31214	20444	16606	13488		5.41	31218	20.10	64000
	292.19	33080	31187	31184	31180	20444	16606	13488		4.79	31185	17.77	64000
	324.10	33051	31160	31157	31152	20444	16606	13488		4.32	31157	16.02	64000
	361.67	33021	31132	31129	31124	20444	16606	13488		3.87	31130	14.34	64000
	392.06	33001	31112	31110	31105	20444	16606	13488		3.57	31111	13.22	64000
	425.00	32981	31094	31091	29040	20444	16606	13488		3.29	31093	12.17	64000
	489.29	33401	30405	29394	27162	20143	16362	13290		2.86	30405	10.35	57000
	552.50	33401	30405	29372	27142	20143	16362	13290		2.53	30405	9.15	57000
	620.00	32898	31016	31013	28928	20444	16606	13488		2.26	31015	8.34	64000
	694.06	33401	30405	29334	27107	20143	16362	13290		2.02	30405	7.31	57000
	786.60	33401	30405	29315	27089	20143	16362	13290		1.78	31269	6.62	57000
	839.58	33401	30405	29306	27080	20143	16362	13290		1.67	31503	6.26	57000
	987.10	33401	30405	29284	27060	20143	16362	13290		1.42	32092	5.42	57000
	1178.13	33401	30405	29261	27039	20143	16362	13290		1.19	32748	4.64	57000
	1388.11	33401	30405	29242	27022	20143	16362	13290		1.01	33369	4.01	57000
	1612.00	33401	30405	29226	27007	20143	16362	13290		0.87	33945	3.51	57000
1947.83	33401	30405	29208	26990	20143	16362	13290	0.72	34688	2.97	57000		
2341.15	26829	24995	22517	20807	17321	16006	13036	0.60	28999	2.07	39000		

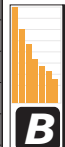

P _{tn}	PH	FCB	FS FP	H HU	T
2803	26,0	23,4	21,3	22,1	27,2
2804	21,1	17,5	16,0	16,5	20,3



1.2 Prestazioni

1.2 Performances

1.2 Leistungen

EX		n ₂ X h								10000 Hours Life				T _{max} [Nm]
Stadio Stage Stufe	ir	T _N [Nm]								n ₁ [rpm]	n ₂ [rpm]	T _N [Nm]	P ₁ [kW]	
		10000	20000	50000	100000	500000	1000000	2000000	2000000					
1	3.52	40671	38026	38024	38021	27669	22474	18255	1400	1400	397.73	14853	637.72	71000
	4.00	42571	42569	42564	42556	27259	22141	17984			350.00	15205	574.49	72000
	4.71	41489	41487	38764	35820	26526	21545	17500			297.24	15539	498.60	64000
	5.85	37783	34394	31682	29276	24371	21379	17365			239.32	16455	425.11	51000
2	12.32	40671	38026	38024	32172	19851	16124	13097	1400	1400	113.64	15518	196.44	71000
	14.00	40128	40127	40122	35184	21710	17634	14323			100.00	17634	196.44	72000
	16.47	39244	39242	36816	34020	24325	19758	16049			85.00	20745	196.43	64000
	19.41	39032	39030	36629	33847	24128	19598	15918			72.13	21616	173.68	64000
	24.31	38766	38764	36394	33630	23453	19050	15473			57.59	22480	144.22	64000
	28.24	38604	38603	36251	33498	22937	18631	15133			49.58	22996	127.01	64000
	35.08	35826	33106	29824	27559	22942	21379	17365			39.91	23538	104.65	51000
	42.38	35681	32971	29703	27447	22848	21379	17365			33.03	23953	88.13	51000
3	44.35	40119	38026	38024	32172	19851	16124	13097	1400	1400	31.57	22788	81.88	71000
	50.40	38714	38712	38708	35184	21710	17634	14323			27.78	25896	81.88	72000
	59.29	37957	37956	35676	32967	24325	19758	16049			23.61	29893	80.33	64000
	70.00	37842	37841	35574	32872	24325	19758	16049			20.00	30376	69.15	64000
	82.50	37737	37736	35480	32786	24128	19598	15918			16.97	30869	59.62	64000
	87.53	37701	37700	35448	32756	23453	19050	15473			15.99	31050	56.51	64000
	102.30	38238	38237	38232	34898	21533	17491	14207			13.69	31763	49.49	72000
	110.22	38197	38196	38191	33922	20931	17001	13809			12.70	31574	45.64	72000
	123.75	38137	38135	38131	34898	21533	17491	14207			11.31	33630	43.29	72000
	155.00	38028	38027	38022	33922	20931	17001	13809			9.03	34974	35.95	72000
	175.06	37352	37351	35137	32469	22937	18631	15133			8.00	33306	30.33	64000
	211.76	37276	37274	35069	32406	22937	18631	15133			6.61	33970	25.56	64000
	226.54	34842	32196	29004	26802	22311	20914	17365			6.18	28312	19.91	51000
	263.08	34796	32153	28966	26766	22282	20886	17365			5.32	28761	17.42	51000
	317.88	34742	32104	28921	26725	22247	20854	17365			4.40	29342	14.69	51000
	4	175.39	37974	37972	37968	35184	21710	17634			14323	1400	1400	7.98
206.71		37906	37905	37900	34898	21533	17491	14207	6.77	37898	30.19			72000
244.04		37843	37842	37837	34898	21533	17491	14207	5.74	37836	25.55			72000
301.57		39685	38026	38024	31911	19690	15993	12991	4.64	38025	20.76			71000
317.18		37754	37753	37748	33922	20931	17001	13809	4.41	37749	19.59			72000
342.69		37730	37729	37724	34898	21533	17491	14207	4.09	37726	18.15			72000
404.57		37681	37680	37675	34898	21533	17491	14207	3.46	37678	15.34			72000
445.90		37655	37653	37649	33922	20931	17001	13809	3.14	37651	13.91			72000
507.69		37621	37619	37615	34898	21533	17491	14207	2.76	37618	12.22			72000
557.57		39504	38026	38024	31911	19690	15993	12991	2.51	38026	11.23			71000
633.60		37568	37567	37562	34898	21533	17491	14207	2.21	37567	9.77			72000
736.56		37536	37534	37530	34898	21533	17491	14207	1.90	37534	8.39			72000
793.60		37520	37519	37515	33922	20931	17001	13809	1.76	37519	7.77			72000
922.56		37491	37490	37485	33922	20931	17001	13809	1.52	37491	6.70			72000
1009.95		36861	36859	36898	32063	22937	18631	15133	1.39	36860	6.03			64000
1116.00		37458	37456	37452	33922	20931	17001	13809	1.25	37457	5.51			72000
1260.42		36824	36823	36665	32033	22937	18631	15133	1.11	36824	4.81			64000
1312.94		36818	36816	36660	32028	23453	19050	15473	1.07	36818	4.64			64000
1524.71		36796	36794	36460	32009	22937	18631	15133	0.92	36796	3.98			64000
1894.15		34423	31809	28655	26479	22043	20662	17365	0.74	35465	3.09			51000
2288.77	34403	31790	28639	26464	22030	20650	17365	0.61	36473	2.62	51000			

5-6 5,6 stadi/stages/stufen
A richiesta / On request / Auf Anfrage

P _{TN}	PH	FS FP	H HU	T
3001	64.3	32.7	36.6	73.7
3002	47.7	29.6	31.9	53.1
3003	27.8	20.4	21.7	34.1
3004	23.9	16.0	17.0	26.2

1.2 Prestazioni

1.2 Performances

1.2 Leistungen

Stadio Stage Stufe	ir	$n_2 \times h$							10000 Hours Life				T_{max} [Nm]
		T_N [Nm]							n_1 [rpm]	n_2 [rpm]	T_N [Nm]	P_1 [kW]	
		10000	20000	50000	100000	500000	1000000	2000000					
2	8.90	15173	15172	15170	15167	15140	15107	15041	1400	157.30	15069	269.79	71000
	11.90	20284	20283	20279	20273	20226	20167	17500		117.65	20146	269.77	64000
	14.79	25199	25197	25191	25182	23492	21379	17365		94.66	21734	234.16	51000
	16.67	15234	15203	15202	15200	14098	13027	12796		83.98	13289	127.02	72000
	19.61	17922	17885	17884	17882	16281	15278	14959		71.39	15634	127.03	64000
	24.36	22219	22219	22217	22214	19733	18884	17365		57.47	19422	127.04	51000
	27.56	11481	10609	9557	8831	7352	7111	6902		50.80	7338	42.43	72000
	32.42	13259	12252	11037	10199	8490	8322	8034		43.18	8633	42.43	64000
	40.27	16070	14849	13377	12361	10475	10251	9809		34.77	10725	42.44	51000
3	31.16	21657	21654	21644	21628	19851	16124	13097	1400	44.93	20499	107.16	71000
	35.41	24610	24606	24593	24572	21710	17634	14323		39.54	23294	107.16	72000
	41.66	28952	28946	28929	28899	24325	19758	16049		33.61	27405	107.16	64000
	49.10	34121	34113	34088	33085	24128	19598	15918		28.51	28556	94.72	64000
	52.27	36326	36317	36289	33922	20931	17001	13809		26.78	25242	78.65	72000
	61.50	37931	37930	35653	32946	23453	19050	15473		22.76	29697	78.64	64000
	71.42	37829	37827	35562	32861	22937	18631	15133		19.60	30376	69.27	64000
	88.72	35225	32550	29323	27096	22556	21144	17365		15.78	25724	47.23	51000
	101.31	37484	37479	35373	32687	23453	19050	15473		13.82	31504	50.66	64000
	117.65	37537	37536	35302	32621	22937	18631	15133		11.90	31981	44.28	64000
	146.15	34999	32341	29135	26923	22412	21008	17365		9.58	27055	30.16	51000
	176.60	34927	32275	29075	26867	22366	20965	17365		7.93	27588	25.45	51000
	208.08	28550	26382	23767	22425	20471	19064	17365		6.73	22976	17.99	51000
	241.64	32595	30120	27134	25948	22298	20902	17365		5.79	26682	17.97	51000
	291.98	34766	32125	28941	26743	22262	20868	17365		4.79	29079	16.21	51000
4	112.18	39120	38026	38024	32172	19851	16124	13097	1400	12.48	30104	44.70	71000
	127.48	38122	38120	38116	35184	21710	17634	14323		10.98	34209	44.69	72000
	150.50	38042	38040	38036	35184	21710	17634	14323		9.30	35956	39.79	72000
	177.38	37969	37967	37963	34898	21533	17491	14207		7.89	37466	35.17	72000
	222.17	37878	37877	37872	33922	20931	17001	13809		6.30	37870	28.39	72000
	258.76	37822	37821	37816	34898	21533	17491	14207		5.41	37816	24.34	72000
	292.19	37781	37779	37775	34898	21533	17491	14207		4.79	37775	21.53	72000
	324.10	37747	37746	37741	33922	20931	17001	13809		4.32	37742	19.40	72000
	366.67	37710	37708	37704	34898	21533	17491	14207		3.82	37706	17.14	72000
	392.06	37690	37689	37684	33922	20931	17001	13809		3.57	37686	16.01	72000
	426.25	37667	37665	37661	34898	21533	17491	14207		3.28	37663	14.70	72000
	459.26	37647	37645	37641	33922	20931	17001	13809		3.05	37644	13.66	72000
	483.08	37634	37632	37628	34898	21533	17491	14207		2.90	37631	12.99	72000
	533.89	37608	37607	37603	33922	20931	17001	13809		2.62	37606	11.72	72000
	606.22	37578	37577	37572	34898	21533	17491	14207		2.31	37576	10.33	72000
	645.83	37564	37563	37558	33922	20931	17001	13809		2.17	37562	9.70	72000
	759.31	37529	37528	37524	33922	20931	17001	13809		1.84	37528	8.22	72000
	826.67	36898	36896	34731	32094	22937	18631	15133		1.69	36897	7.42	64000
	882.70	37500	37498	37494	33922	20931	17001	13809		1.59	37499	7.09	72000
	1067.78	37465	37464	37459	33922	20931	17001	13809		1.31	37465	5.84	72000
	1205.96	36831	36830	34671	32039	22937	18631	15133		1.16	36831	5.08	64000
	1458.82	36802	36801	34645	32015	22937	18631	15133		0.96	36802	4.20	64000
	1812.31	34428	31813	28659	26483	22046	20665	17365		0.77	35233	3.23	51000
	2189.87	34407	31794	28642	26467	22033	20653	17365		0.64	36235	2.76	51000



P_{TN}	PH	FS FP	H HU	T
3002	43.3	31.8	33.3	46.8
3003	26.6	21.1	22.1	31.3
3004	21.6	15.8	16.5	23.3



1.2 Prestazioni

1.2 Performances

1.2 Leistungen

EX 	n ₂ X h								10000 Hours Life				T _{max} [Nm]		
	Stadio Stage Stufe	ir	T _N [Nm]								n ₁ [rpm]	n ₂ [rpm]		T _N [Nm]	P ₁ [kW]
			10000	20000	50000	100000	500000	1000000	2000000						
1	4.04	52449	49448	49444	45594	28133	22851	18561	1400	346.53	15739	588.77	90000		
	5.12	45607	41637	41635	41632	27582	22404	18197		273.44	16568	489.05	75000		
	6.00	42395	38538	38536	36988	27034	21958	17836		233.33	17030	428.95	64000		
	7.36	34208	31611	28477	26314	21906	20504	17658		190.22	17926	368.10	43000		
2	14.15	48728	46516	43645	35451	21875	17768	14432	1400	98.94	17825	196.46	90000		
	16.68	49040	46234	43291	35163	21697	17623	14315		83.93	18574	173.66	90000		
	17.91	45607	41637	41635	41632	25796	20953	17019		78.17	22560	196.45	75000		
	21.11	45607	41637	41635	41468	25587	20783	16881		66.32	23508	173.67	75000		
	26.44	45607	41637	41635	40308	24872	20202	16409		52.95	24447	144.20	75000		
	30.71	45607	41637	41635	38668	24324	19757	16048		45.59	25008	127.00	75000		
	36.00	42395	38538	37612	34755	27034	21958	17836		38.89	29151	126.29	64000		
	43.50	42395	38538	35855	33132	26934	21877	17770		32.18	30294	108.60	64000		
	53.39	32206	29760	26810	24774	20623	19304	17658		26.22	22197	64.83	43000		
	3	50.95	46085	44806	43645	35451	21875	17768		14432	1400	27.48	26178	81.88	90000
60.15		45840	44653	43645	35451	21875	17768	14432	23.28	27515		72.91	90000		
64.48		45607	41637	41635	40561	25796	20953	17019	21.71	33131		81.87	75000		
76.13		45607	41637	41635	40444	25796	20953	17019	18.39	34824		72.89	75000		
89.72		45607	41637	41635	40338	25587	20783	16881	15.60	36286		64.43	75000		
95.53		45607	41637	41635	40300	25796	20953	17019	14.66	37278		62.20	75000		
103.41		46915	44231	43291	35163	21697	17623	14315	13.54	32108		49.48	90000		
112.59		45607	41637	41635	40205	25587	20783	16881	12.43	38844		54.95	75000		
130.88		45607	41637	41635	40124	25587	20783	16881	10.70	39817		48.49	75000		
158.33		45607	41637	41635	40030	25587	20783	16881	8.84	40596		40.85	75000		
198.31		45607	41637	41635	39931	24872	20202	16409	7.06	41547		33.39	75000		
230.29		45607	41637	39567	36563	24324	19757	16048	6.08	38696		26.78	75000		
270.00		42395	38538	36491	33720	27034	21958	17836	5.19	36340		21.47	64000		
326.25		40937	37828	34078	31490	26934	21877	17770	4.29	34677		16.93	64000		
400.40		31423	29037	26158	24172	20122	18835	17658	3.50	27246		10.85	43000		
4		177.30	44648	43910	43645	35451	21875	17768	14432	1400		7.90	38054	35.37	90000
	209.31	44515	43827	43645	35451	21875	17768	14432	6.69		39997	31.48	90000		
	246.69	46407	43752	43291	35163	21697	17623	14315	5.68		41677	27.85	90000		
	262.66	44349	43725	43645	35451	21875	17768	14432	5.33		42816	26.85	90000		
	309.57	46307	43658	43291	35163	21697	17623	14315	4.52		43655	23.22	90000		
	346.42	46262	43615	43291	35163	21697	17623	14315	4.04		43612	20.73	90000		
	379.24	46227	43582	43291	35163	21697	17623	14315	3.69		43580	18.92	90000		
	408.96	46199	43556	43291	35163	21697	17623	14315	3.42		43554	17.53	90000		
	440.86	46173	43531	43291	35163	21697	17623	14315	3.18		43529	16.29	90000		
	513.21	46122	43483	43291	35163	21697	17623	14315	2.73		43482	13.97	90000		
	543.44	43930	43466	43462	35451	21875	17768	14432	2.58		43465	13.19	90000		
	640.49	46054	43419	43291	35163	21697	17623	14315	2.19		43419	11.19	90000		
	698.88	45607	41637	41635	39539	24872	20202	16409	2.00		41637	9.80	75000		
	744.57	46012	43379	43291	35163	21697	17623	14315	1.88		43380	9.60	90000		
	810.64	45607	41637	41635	39507	25587	20783	16881	1.73		42842	8.72	75000		
	913.43	45607	41637	41635	39483	25587	20783	16881	1.53		43432	7.82	75000		
	1015.34	45607	41637	41635	39463	24872	20202	16409	1.38		43961	7.14	75000		
	1098.33	45607	41637	38834	35885	24324	19757	16048	1.27		44358	6.63	75000		
	1180.33	45607	41637	41635	39436	24872	20202	16409	1.19		44725	6.26	75000		
	1328.62	45607	41637	38777	35833	24324	19757	16048	1.05		45335	5.60	75000		
	1427.82	45607	41637	41635	39405	24872	20202	16409	0.98		45710	5.27	75000		
	1658.12	45607	41637	38718	35778	24324	19757	16048	0.84		46499	4.60	75000		
	1944.00	42395	38538	36085	33345	27034	21958	17836	0.72		44018	3.73	64000		
	2349.00	40148	37099	33421	30883	26934	21877	17770	0.60		42586	3.01	64000		
2882.86	31141	28776	25923	23955	19941	18666	17658	0.49	34207	1.97	43000				

5-6 5,6 stadi/stages/stufen
A richiesta / On request / Auf Anfrage

P _{TN}	PS PSB	S-SB-SU FS-FSR
3501	91.3	47.9
3502	54.1	35.5
3503	34.7	23.8
3504	27.6	19.5

1.2 Prestazioni

1.2 Performances

1.2 Leistungen

Stadio Stage Stufe	ir	n ₂ X h								10000 Hours Life				T _{max} [Nm]	
		T _N [Nm]								n ₁ [rpm]	n ₂ [rpm]	T _N [Nm]	P ₁ [kW]		
		10000	20000	50000	100000	500000	1000000	2000000							
3	35.80	24878	24873	24860	24838	21875	17768	14432	1400	39.11	23548	107.15	90000		
	45.31	31485	31478	31457	31422	25796	20953	17019		30.90	29804	107.15	75000		
	53.40	37106	37096	37067	37019	25587	20783	16881		26.22	31055	94.74	75000		
	66.88	45607	41637	41635	40308	24872	20202	16409		20.93	32296	78.65	75000		
	77.67	45607	41637	40534	37456	24324	19757	16048		18.02	33034	69.26	75000		
	91.06	42395	38538	36958	34151	27034	21958	17836		15.37	32518	58.15	64000		
	103.13	38156	38152	36891	34089	27034	21958	17836		13.58	32923	52.02	64000		
	110.17	40763	40758	39121	36150	24872	20202	16409		12.71	35176	52.02	75000		
	127.94	45607	41637	40027	36987	24324	19757	16048		10.94	36610	46.60	75000		
	150.00	42395	38538	36712	33924	27034	21958	17836		9.33	34192	37.12	64000		
	181.25	41365	38223	34434	31819	26934	21877	17770		7.72	32769	29.43	64000		
	211.53	28969	26769	24115	22788	20771	19381	16048		6.62	23357	17.99	75000		
	255.60	34258	31656	28518	27387	24096	19572	15898		5.48	28223	17.99	75000		
	299.67	39443	36447	32834	31532	26934	21877	17770		4.67	33089	17.98	64000		
	367.77	31443	29055	26175	24187	20135	18847	17658		3.81	27001	11.97	43000		
	4	163.10	45607	41637	41635	40017	25796	20953		17019	1400	8.58	40719	41.57	75000
		192.55	45607	41637	41635	39943	25796	20953		17019		7.27	41420	35.83	75000
226.94		45607	41637	41635	39876	25587	20783	16881	6.17	41634		30.57	75000		
261.57		46380	43727	43291	35163	21697	17623	14315	5.35	42416		27.00	90000		
295.36		46327	43676	43291	35163	21697	17623	14315	4.74	43673		24.63	90000		
331.06		45607	41637	41635	39741	25587	20783	16881	4.23	41635		20.96	75000		
370.65		46236	43590	43291	35163	21697	17623	14315	3.78	43588		19.61	90000		
396.62		45607	41637	41635	39685	24872	20202	16409	3.53	41636		17.49	75000		
430.88		46181	43538	43291	35163	21697	17623	14315	3.25	43537		16.84	90000		
469.12		45607	41637	41635	39637	25587	20783	16881	2.98	41636		14.76	75000		
501.60		45607	41637	41635	39619	24872	20202	16409	2.79	41636		13.82	75000		
545.35		45607	41637	41635	39598	25587	20783	16881	2.57	41636		12.73	75000		
587.58		45607	41637	41635	39579	24872	20202	16409	2.38	41636		11.79	75000		
659.70		45607	41637	41635	39552	25587	20783	16881	2.12	41637		10.50	75000		
712.39		46024	43391	43291	35163	21697	17623	14315	1.97	43391		10.17	90000		
826.29		45607	41637	41635	39503	24872	20202	16409	1.69	42936		8.63	75000		
901.64		45607	41637	41635	39486	25587	20783	16881	1.55	43367		8.00	75000		
971.47		45607	41637	41635	39471	24872	20202	16409	1.44	43739		7.49	75000		
1090.70		45607	41637	41635	39450	25587	20783	16881	1.28	44322		6.75	75000		
1366.13		45607	41637	41635	39412	24872	20202	16409	1.02	45479		5.52	75000		
1586.47		45607	41637	38729	35788	24324	19757	16048	0.88	46264		4.84	75000		
1860.00		42395	38538	36091	33350	27034	21958	17836	0.75	43796		3.91	64000		
2247.50		40158	37109	33430	30891	26934	21877	17770	0.62	42384		3.13	64000		
2758.30		31144	28779	25926	23957	19943	18668	17658	0.51	33983		2.06	43000		



P _{TN}	PS PSB	S-SB-SU FS-FSR
3503	28,3	21,0
3504	24,3	18,4

1.2 Prestazioni

1.2 Performances

1.2 Leistungen

EX		n ₂ X h								10000 Hours Life				T _{max} [Nm]			
Stadio Stage Stufe	ir	T _N [Nm]								n ₁ [rpm]	n ₂ [rpm]	T _N [Nm]	P ₁ [kW]				
		10000	20000	50000	100000	500000	1000000	2000000									
2	15.04	49225	46409	46405	45594	28133	22851	18561	1400	93.09	23348	242.11	90000				
	16.54	49055	46248	46244	45594	28133	22851	18561						84.64	24023	226.50	90000
	21.23	48641	45858	45854	45594	28133	22851	18561						65.94	25891	190.18	90000
	25.19	48385	45616	45612	45594	28133	22851	18561						55.58	27254	168.74	90000
	31.89	45607	41637	41635	41175	27582	22404	18197						43.90	28680	140.25	75000
	37.38	42395	38538	37579	34725	27034	21958	17836						37.45	29482	122.99	64000
	45.88	32302	29849	26890	24848	20685	19362	17658						30.51	21882	74.37	43000
3	54.15	47464	44748	44744	44738	28133	22851	18561	1400	25.85	34288	100.88	90000				
	63.93	47306	44599	44595	44589	28133	22851	18561						21.90	36039	89.83	90000
	70.30	47221	44519	44515	44509	28133	22851	18561						19.91	37081	84.03	90000
	80.22	47110	44414	44410	44404	28133	22851	18561						17.45	38579	76.62	90000
	90.70	47012	44323	44319	43852	28133	22851	18561						15.44	40027	70.34	90000
	102.56	46921	44236	44232	44226	28133	22851	18561						13.65	41530	64.52	90000
	113.22	46851	44170	44167	44160	28133	22851	18561						12.37	42780	60.23	90000
	131.62	46751	44076	44072	44066	28133	22851	18561						10.64	44065	53.36	90000
	156.20	46647	43978	43974	43314	28133	22851	18561						8.96	43858	44.73	90000
	170.06	45607	41637	41635	39997	27582	22404	18197						8.23	40894	38.31	75000
	188.95	46540	43877	43874	43157	28133	22851	18561						7.41	43870	37.00	90000
	239.15	45607	41637	41635	39856	27582	22404	18197						5.85	41635	27.72	75000
	280.38	42395	38538	36479	33709	27034	21958	17836						4.99	36485	20.72	64000
	344.11	31459	29070	26188	24199	20145	18856	17658						4.07	26810	12.42	43000
	4	222.47	46457	43799	43795	43788	28133	22851						18561	1400	6.29	43793
244.65		46411	43756	43752	43745	28133	22851	18561	5.72	43751	29.44	90000					
265.95		46373	43720	43716	43709	28133	22851	18561	5.26	43715	27.05	90000					
307.01		46311	43661	43657	43651	28133	22851	18561	4.56	43658	23.42	90000					
343.55		46265	43618	43614	43608	26940	21882	17774	4.08	43615	20.94	90000					
376.10		46230	43585	43581	43575	28133	22851	18561	3.72	43583	19.08	90000					
405.58		46202	43559	43555	43549	28133	22851	18561	3.45	43557	17.68	90000					
437.22		46176	43534	43530	43523	28133	22851	18561	3.20	43532	16.39	90000					
508.97		46124	43485	43481	43475	28133	22851	18561	2.75	43484	14.07	90000					
550.24		46100	43462	43458	43452	28133	22851	18561	2.54	43461	12.99	90000					
635.19		46056	43421	43417	43411	28133	22851	18561	2.20	43421	11.24	90000					
738.41		46014	43382	43378	43371	28133	22851	18561	1.90	43382	9.70	90000					
803.94		45607	41637	41635	39509	27582	22404	18197	1.74	42802	8.76	75000					
918.53		45959	43329	43325	43319	28133	22851	18561	1.52	43330	7.75	90000					
1031.72		45607	41637	41635	39460	27582	22404	18197	1.36	44041	7.05	75000					
1162.54		45607	41637	41635	39439	27582	22404	18197	1.20	44647	6.30	75000					
1360.47		45873	43248	43244	42164	28133	22851	18561	1.03	45643	5.53	90000					
1450.85		45607	41637	41635	39403	27582	22404	18197	0.96	45793	5.17	75000					
1721.89		45607	41637	41635	39377	27582	22404	18197	0.81	46700	4.45	75000					
2018.77		42395	38538	36081	33341	27034	21958	17836	0.69	44209	3.59	64000					
2477.58		42395	38538	36058	33320	27034	21958	17836	0.57	45257	3.04	64000					

5-6

5,6 stadi/stages/stufen
A richiesta / On request / Auf Anfrage

P _{TN}	PS PSB	S-SB-SU FS-FSR
3602	56.1	37.5
3603	37.0	26.1
3604	29.3	21.2

1.2 Prestazioni

1.2 Performances

1.2 Leistungen

		n ₂ X h								10000 Hours Life				T _{max} [Nm]			
		T _N [Nm]								n ₁ [rpm]	n ₂ [rpm]	T _N [Nm]	P ₁ [kW]				
Stadio Stage Stufe	ir	10000	20000	50000	100000	500000	1000000	2000000									
3	38.05	42762	42754	42730	42690	28133	22851	18561	1400					36.79	30844	132.02	90000
	41.84	47025	45006	45002	44995	28133	22851	18561						33.46	31735	123.54	90000
	53.70	47472	44756	44752	44746	28133	22851	18561						26.07	34203	103.74	90000
	63.73	47309	44602	44598	44283	28133	22851	18561						21.97	36006	92.04	90000
	79.32	45607	41637	41635	40417	27582	22404	18197						17.65	37696	77.41	75000
	88.45	47032	44341	44337	44330	28133	22851	18561						15.83	39726	73.17	90000
	104.97	46904	44220	44217	43693	28133	22851	18561						13.34	41820	64.91	90000
	132.86	45607	41637	41635	40116	27582	22404	18197						10.54	39878	48.90	75000
	155.77	42395	38538	36696	33909	27034	21958	17836						8.99	34324	35.90	64000
	185.09	39759	36740	33098	30891	27582	22404	18197						7.56	31573	27.77	75000
	219.67	45607	41637	38522	36526	27582	22404	18197						6.37	37471	27.77	75000
	257.54	42395	38538	36507	33734	27034	21958	17836						5.44	36160	22.89	64000
	316.07	31480	29089	26205	24215	20158	18869	17658						4.43	26570	13.69	43000
4	136.97	46726	44053	44049	44042	28133	22851	18561	1400					10.22	44042	53.56	90000
	150.62	46668	43998	43994	43988	28133	22851	18561						9.29	43989	48.63	90000
	177.82	46573	43908	43904	43898	28133	22851	18561						7.87	43901	41.11	90000
	193.30	46528	43866	43862	43856	28133	22851	18561						7.24	43859	37.78	90000
	223.15	46455	43797	43793	43787	28133	22851	18561						6.27	43792	32.67	90000
	248.12	46405	43750	43746	43739	28133	22851	18561						5.64	43745	29.36	90000
	292.92	46331	43680	43676	43670	28133	22851	18561						4.78	43676	24.84	90000
	318.42	46296	43647	43643	43637	28133	22851	18561						4.40	43644	22.85	90000
	367.59	46239	43593	43589	43583	28133	22851	18561						3.81	43591	19.76	90000
	395.10	46212	43568	43564	42669	28133	22851	18561						3.54	43566	18.35	90000
	427.32	46184	43541	43537	43531	28133	22851	18561						3.28	43539	16.99	90000
	471.74	46149	43509	43505	43499	28133	22851	18561						2.97	43508	15.38	90000
	526.46	46113	43475	43471	43465	28133	22851	18561						2.66	43474	13.76	90000
	607.75	46069	43433	43430	43423	28133	22851	18561						2.30	43433	11.89	90000
	706.51	46026	43393	43389	43383	28133	22851	18561						1.98	43393	10.22	90000
	787.31	45997	43366	43362	42350	28133	22851	18561						1.78	43366	9.19	90000
	839.61	45607	41637	41635	39500	27582	22404	18197						1.67	43015	8.55	75000
	906.68	45962	43332	43328	43322	28133	22851	18561						1.54	43333	7.94	90000
	996.46	45607	41637	41635	39467	27582	22404	18197						1.40	43866	7.31	75000
	1076.06	45922	43295	43291	42237	28133	22851	18561						1.30	43295	6.70	90000
	1171.55	45607	41637	41635	39437	27582	22404	18197						1.19	44686	6.33	75000
	1388.16	45607	41637	41635	39409	27582	22404	18197						1.01	45563	5.48	75000
	1647.49	45607	41637	41635	39384	27582	22404	18197						0.85	46464	4.70	75000
	1931.54	42395	38538	36086	33346	27034	21958	17836						0.72	43986	3.77	64000
	2370.52	31158	28792	25938	23968	19952	18676	17658						0.59	33228	2.33	43000

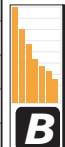

B

P _{TN}	PS PSB	S-SB-SU FS-FSR
3603	32.6	25.4
3604	25.5	19.6



1.2 Prestazioni

1.2 Performances

1.2 Leistungen

EX		n ₂ X h							10000 Hours Life				T _{max} [Nm]
Stadio Stage Stufe	ir	T _N [Nm]							n ₁ [rpm]	n ₂ [rpm]	T _N [Nm]	P ₁ [kW]	
		10000	20000	50000	100000	500000	1000000	2000000					
1	4.18	59828	55392	55389	55385	37510	30468	24748	1400	334.93	21201	766.54	95000
	4.89	54742	50201	50199	50196	36775	29871	24263					
	6.00	49674	45155	45153	41802	34798	29278	23781					
2	15.56	57024	55392	55389	55385	37066	30107	24454	1400	89.97	31076	311.45	95000
	17.11	56829	55392	55389	55385	36916	29985	24356					
	20.00	54742	50201	50199	50196	36775	29871	24263					
	21.95	56358	55392	55389	55385	36029	29265	23770					
	25.67	54742	50201	50199	50196	36775	29871	24263					
	30.46	54742	50201	50199	50196	36775	29871	24263					
	37.38	49674	45155	42469	39244	32669	29278	23781					
3	56.00	55015	55012	55006	53763	33174	26945	21886	1400	25.00	40842	116.21	95000
	61.59	54909	54907	54901	54890	35456	28799	23392					
	72.71	54737	54735	54729	54718	34943	28383	23054					
	79.04	54656	54654	54647	54637	36029	29265	23770					
	85.00	54742	50201	50199	49500	36775	29871	24263					
	93.31	54504	54502	54495	54485	36029	29265	23770					
	106.07	54395	54393	54386	54360	33542	27245	22129					
	117.09	54315	54313	54307	54296	36029	29265	23770					
	136.12	54201	54199	54193	54182	36029	29265	23770					
	164.66	54069	54067	51830	50649	36029	29265	23770					
	192.50	54742	50201	50199	48971	36775	29871	24263					
	228.46	54742	50201	50199	48885	36775	29871	24263					
	280.38	49524	45155	41226	38095	31713	29278	23781					
4	214.32	53906	53904	53897	46876	28924	23493	19083	1400	6.53	53263	40.92	95000
	253.02	53814	53811	53805	52651	32488	26388	21434					
	275.05	53770	53768	53762	53751	34442	27976	22724					
	309.96	53711	53708	53702	51690	31894	25906	21042					
	355.31	53647	53645	53639	44700	27582	22403	18197					
	388.97	53607	53605	53599	53588	33902	27537	22367					
	419.46	53575	53573	53567	50208	30980	25164	20439					
	452.18	53545	53543	53536	53526	33542	27245	22129					
	499.18	53506	53504	53498	53487	36029	29265	23770					
	556.44	53466	53464	51194	48976	31383	25491	20705					
	611.92	53433	53431	53424	53414	33542	27245	22129					
	701.97	53387	53385	49909	48772	36029	29265	23770					
	797.31	53348	52423	47226	43640	35164	28562	23199					
	932.00	53303	52350	47160	43579	35164	28562	23199					
	1000.55	53283	52319	47132	43553	35164	28562	23199					
	1110.58	54742	50201	50199	48359	36775	29871	24263					
	1386.00	54742	50201	50199	48314	36775	29871	24263					
	1644.92	54742	50201	50199	48282	36775	29871	24263					
	2018.77	48983	45155	40776	37680	31367	29278	23781					

5-6 5,6 stadi/stages/stufen
A richiesta / On request / Auf Anfrage

P _{TN}	PS PSB	S-SB-SU FS-FSB-FSR
4201	91.3	47.9
4202	56.1	37.5
4203	37.0	26.1
4204	29.3	21.2

1.2 Prestazioni

1.2 Performances

1.2 Leistungen

		n ₂ X h								10000 Hours Life				T _{max} [Nm]
		T _N [Nm]								n ₁ [rpm]	n ₂ [rpm]	T _N [Nm]	P ₁ [kW]	
Stadio Stage Stufe	ir	10000	20000	50000	100000	500000	1000000	2000000						
3	39.35	44225	44216	44191	44148	37066	30107	24454	1400	1400	35.58	41050	169.93	95000
	43.27	48633	48623	48592	48541	36916	29985	24356			32.35	42065	158.32	95000
	55.53	55024	55022	55015	55005	36029	29265	23770			25.21	44245	129.78	95000
	65.91	54837	54806	49372	45623	35164	28562	23199			21.24	41870	103.47	95000
	77.05	54742	50201	50199	49579	36775	29871	24263			18.17	46318	97.92	85000
	83.33	52494	50201	50007	46210	36775	29871	24263			16.80	43557	85.14	85000
	91.48	54521	54519	54314	50189	36029	29265	23770			15.30	47814	85.11	95000
	108.57	54376	54075	48714	45015	35164	28562	23199			12.89	43730	65.58	95000
	126.92	54742	50201	50199	49214	36775	29871	24263			11.03	48667	62.45	85000
	155.77	49674	45155	41471	38322	31901	29278	23781			8.99	38791	40.57	70000
	176.81	38180	35281	31783	29536	27346	25027	24263			7.92	30161	27.79	85000
	209.85	44437	41063	36992	34930	31862	29702	24263			6.67	35796	27.78	85000
257.54	49561	45155	41257	38124	31737	29278	23781	5.44	40866	25.87	70000			
4	141.65	54173	54171	54164	53763	33174	26945	21886	1400	1400	9.88	53952	63.43	95000
	155.78	54107	54104	54098	54087	35456	28799	23392			8.99	54090	57.86	95000
	183.90	53998	53996	53990	53979	34943	28383	23054			7.61	53984	48.88	95000
	199.92	53947	53945	53939	53928	36029	29265	23770			7.00	53934	44.92	95000
	230.78	53864	53862	53855	53845	33902	27537	22367			6.07	53853	38.90	95000
	256.61	53806	53804	53798	53787	35456	28799	23392			5.46	53797	34.95	95000
	275.48	53769	53767	53761	52986	32694	26556	21570			5.08	53761	32.50	95000
	302.94	53722	53720	53713	53703	34943	28383	23054			4.62	53714	29.53	95000
	345.70	53659	53657	53651	51406	31719	25764	20927			4.05	53653	25.86	95000
	380.17	53617	53615	53609	53598	33902	27537	22367			3.68	53611	23.48	95000
	401.87	53593	53591	51514	49282	31383	25491	20705			3.48	53588	22.19	95000
	441.94	53554	53552	53546	53535	33542	27245	22129			3.17	53549	20.20	95000
	487.88	53515	53513	53507	53496	36029	29265	23770			2.87	53511	18.27	95000
	516.67	54742	50201	50199	48563	36775	29871	24263			2.71	50201	16.19	85000
	567.16	53459	53457	53451	53440	36029	29265	23770			2.47	53456	15.71	95000
	628.54	53424	53422	53415	53405	33902	27537	22367			2.23	53421	14.18	95000
	730.68	53375	53373	53366	53356	33542	27245	22129			1.92	53373	12.19	95000
	806.63	53344	53342	53336	53326	36029	29265	23770			1.74	53343	11.04	95000
	891.85	54742	50201	50199	48410	36775	29871	24263			1.57	51988	9.71	85000
	957.31	53295	52338	47149	43569	35164	28562	23199			1.46	53294	9.26	95000
	1119.18	54742	50201	50199	48358	36775	29871	24263			1.25	53357	7.94	85000
	1301.05	54742	50201	50199	48326	36775	29871	24263			1.08	54284	6.98	85000
	1573.85	54742	50201	50199	48290	36775	29871	24263			0.89	55480	5.88	85000
	1931.54	48990	45155	40782	37685	31371	29278	23781			0.72	50564	4.33	70000

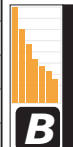

P _{tn}	PS PSB	S-SB-SU FS-FSB-FSR
4203	32.6	25.4
4204	25.5	19.6



1.2 Prestazioni

1.2 Performances

1.2 Leistungen

EX		n ₂ X h								10000 Hours Life				T _{max} [Nm]
Stadio Stage Stufe	ir	T _N [Nm]								n ₁ [rpm]	n ₂ [rpm]	T _N [Nm]	P ₁ [kW]	
		10000	20000	50000	100000	500000	1000000	2000000						
2	15.56	78975	78972	73956	60071	37066	30107	24454	1400	89.97	31076	311.45	145000	
	17.11	78695	78692	73657	59828	36916	29985	24356		81.82	31845	290.25	145000	
	20.00	78676	72150	72147	66742	41182	33450	27170		70.00	37228	290.29	120000	
	25.67	78676	72150	72147	65138	40192	32646	26517		54.54	39158	237.91	120000	
	30.46	70454	65104	58649	54196	39227	31862	25880		45.96	40231	205.97	120000	
	37.38	68715	62463	60865	56243	45273	36773	29869		37.45	48387	201.86	94000	
3	56.00	76073	76070	66190	53763	33174	26945	21886	1400	25.00	40842	116.21	145000	
	61.59	75921	75918	70744	57462	35456	28799	23392		22.73	44915	116.20	145000	
	72.71	75672	75669	69721	56631	34943	28383	23054		19.25	46526	101.94	145000	
	79.04	75555	72906	65679	58390	36029	29265	23770		17.71	49188	99.15	145000	
	85.00	78676	72150	72147	63175	38981	31663	25718		16.47	54392	101.96	120000	
	93.31	75335	72579	65384	58390	36029	29265	23770		15.00	51699	88.26	145000	
	109.08	78676	72150	72147	65138	40192	32646	26517		12.83	60439	88.26	120000	
	117.09	75062	72171	65016	58390	36029	29265	23770		11.96	55343	75.34	145000	
	136.89	78676	72150	72147	65138	40192	32646	26517		10.23	64700	75.33	120000	
	159.13	78676	72150	72147	65138	40192	32646	26517		8.80	67689	67.80	120000	
	192.50	69848	64544	60359	58749	40192	32646	26517		7.27	59625	49.34	120000	
	236.25	68715	62463	59099	54611	45461	37678	30604		5.93	57966	39.12	94000	
	280.38	68715	62463	59002	54522	45273	36773	29869		4.99	59012	33.52	94000	
	4	194.89	74551	71080	53996	43858	27062	21981		17854	1400	7.18	48434	40.91
214.32		74469	74466	57711	46876	28924	23493	19083	6.53	53263		40.92	145000	
253.02		74336	74333	64821	52651	32488	26388	21434	5.53	62880		40.91	145000	
275.05		74272	70982	63945	55819	34442	27976	22724	5.09	63815		38.22	145000	
309.96		74186	74184	63638	51690	31894	25906	21042	4.52	65608		34.89	145000	
336.94		74129	70765	63750	54800	33814	27465	22309	4.16	65109		31.87	145000	
362.37		78676	72150	70991	57663	35580	28900	23474	3.86	72148		32.77	120000	
388.97		74037	74034	67643	54943	33902	27537	22367	3.60	74029		31.36	145000	
419.46		73991	73988	61813	50208	30980	25164	20439	3.34	69782		27.42	145000	
454.74		78676	72150	72147	61292	37819	30719	24951	3.08	72149		26.14	120000	
478.66		73914	73911	63289	51406	31719	25764	20927	2.92	72088		24.77	145000	
526.38		73862	73859	67643	54943	33902	27537	22367	2.66	73857		23.11	145000	
559.59		78676	72150	70602	57347	35385	28741	23345	2.50	72150		21.22	120000	
583.58		78676	72150	72147	65138	40192	32646	26517	2.40	72150		20.37	120000	
615.38		78676	72150	72147	61292	37819	30719	24951	2.28	72150		19.35	120000	
675.52		73737	70169	63213	58390	36029	29265	23770	2.07	69885		17.02	145000	
789.74		78676	72150	72147	65138	40192	32646	26517	1.77	73686		15.34	120000	
843.05		73638	70019	63077	58287	36029	29265	23770	1.66	71518		13.97	145000	
918.08		78676	72150	72147	65138	40192	32646	26517	1.52	74967		13.41	120000	
985.60		78676	72150	72147	65138	40192	32646	26517	1.42	75578		12.63	120000	
1145.76		78676	72150	72147	65138	40192	32646	26517	1.22	76892		11.04	120000	
1362.98		68715	62463	58415	53979	44935	37678	30604	1.03	68504		8.30	94000	
1668.85		68715	62463	58368	53935	44899	36773	29869	0.84	70110		6.93	94000	
2018.77		68715	62463	58328	53898	44868	36773	29869	0.69	71654		5.82	94000	

5-6 5,6 stadi/stages/stufen
A richiesta / On request / Auf Anfrage

P _{tn}	PS PSB	S-SB-SU FS-FSR
6002	68.3	46.1
6003	44.1	31.2
6004	34.7	25.0

1.2 Prestazioni

1.2 Performances

1.2 Leistungen

		n ₂ X h								10000 Hours Life				T _{max} [Nm]			
		T _N [Nm]								n ₁ [rpm]	n ₂ [rpm]	T _N [Nm]	P ₁ [kW]				
Stadio Stage Stufe	ir	10000	20000	50000	100000	500000	1000000	2000000									
3	39.35	44225	44216	44191	44148	37066	30107	24454	1400		35.58	41050	169.93	145000			
	43.27	48633	48623	48592	48541	36916	29985	24356			32.35	42065	158.32	145000			
	55.53	62409	62392	62341	58390	36029	29265	23770			25.21	44245	129.78	145000			
	64.92	72958	72150	72147	65138	40192	32646	26517			21.57	51726	129.81	120000			
	77.05	68115	62942	56702	52396	39227	31862	25880			18.17	48950	103.48	120000			
	94.56	68715	62463	59779	55239	45273	36773	29869			14.81	52824	91.02	94000			
	106.94	67359	67324	62377	57641	40192	32646	26517			13.09	55898	85.13	120000			
	126.92	67207	62103	55946	51698	39227	31862	25880			11.03	51123	65.61	120000			
	155.77	68715	62463	59370	54862	45273	36773	29869			8.99	55533	58.09	94000			
	176.81	38180	35281	31783	29536	27346	25027	25027			7.92	30161	27.79	120000			
	209.85	44437	41063	36992	34930	31862	29702	25880			6.67	35796	27.78	120000			
	257.54	53279	49233	44352	42651	38066	36452	29869			5.44	43932	27.81	94000			
	4	141.65	71014	70964	66190	53763	33174	26945			21886	1400		9.88	53952	63.43	145000
		155.78	74760	74757	70744	57462	35456	28799			23392			8.99	59333	63.47	145000
183.90		74603	74600	69721	56631	34943	28383	23054	7.61	61460	55.65			145000			
199.92		74529	71369	64294	58390	36029	29265	23770	7.00	61873	51.54			145000			
230.78		74408	74405	67643	54943	33902	27537	22367	6.07	63831	46.10			145000			
245.34		78676	72150	70602	57347	35385	28741	23345	5.71	67858	46.11			120000			
275.92		78676	72150	72147	65138	40192	32646	26517	5.07	72147	43.53			120000			
302.94		74203	74200	67452	56631	34943	28383	23054	4.62	68059	37.41			145000			
345.70		74112	74109	63289	51406	31719	25764	20927	4.05	67420	32.49			145000			
380.17		74051	74048	67643	54943	33902	27537	22367	3.68	74043	32.42			145000			
404.15		78676	72150	70602	57347	35385	28741	23345	3.46	72149	29.70			120000			
444.44		78676	72150	72147	61292	37819	30719	24951	3.15	72149	27.04			120000			
487.88		73903	70423	63441	58390	36029	29265	23770	2.87	67585	23.08			145000			
516.67		77314	71442	64360	60642	37418	30393	24687	2.71	69013	22.25			120000			
570.37		78676	72150	72147	65138	40192	32646	26517	2.45	72150	21.03			120000			
663.06		78676	72150	72147	65138	40192	32646	26517	2.11	72150	18.11			120000			
734.81		72993	67450	65072	61292	37819	30719	24951	1.91	67824	15.41			120000			
806.63		73656	70047	63103	58311	36029	29265	23770	1.74	71188	14.74			145000			
854.22		76602	70785	63768	60642	37418	30393	24687	1.64	72409	14.13			120000			
943.01		78676	72150	72147	65138	40192	32646	26517	1.48	75197	13.24			120000			
1096.25		78676	72150	72147	65138	40192	32646	26517	1.28	76504	11.65			120000			
1168.27		68715	62463	58454	54015	44965	36773	29869	1.20	67307	9.61			94000			
1301.05		64968	60034	54083	49976	39227	31862	25880	1.08	64427	8.28			120000			
1573.85		64875	59948	54005	49904	39227	31862	25880	0.89	65746	6.96			120000			
1931.54		68715	62463	58337	53907	44875	36773	29869	0.72	71293	6.11			94000			



P _{tn}	PS PSB	S-SB-SU FS-FSR
6003	37.3	28.7
6004	29.4	22.4



1.2 Prestazioni

1.2 Performances

1.2 Leistungen

EX 	n ₂ X h								10000 Hours Life				T _{max} [Nm]		
	Stadio Stage Stufe	ir	T _N [Nm]						P ₁ [kW]	T _N [Nm]	P ₁ [kW]	T _{max} [Nm]			
10000			20000	50000	100000	500000	1000000	2000000					n ₁ [rpm]	n ₂ [rpm]	
1	4.18	84262	79227	79224	77596	47879	38890	31589	1000	239.23	29936	773.10	145000		
	4.89	78676	72150	72147	72142	47278	38402	31192		204.50	30984	684.00	120000		
	6.00	68715	62463	62460	60051	46408	37695	30618		166.67	32339	581.85	94000		
2	15.16	79054	79051	79042	77596	47879	38890	31589	1400	92.35	39830	409.75	145000		
	16.73	78760	78757	78748	77596	47879	38890	31589		83.68	41025	382.42	145000		
	19.56	78676	72150	72147	72142	47278	38402	31192		71.57	42454	338.47	120000		
	21.75	78039	78036	78027	77596	47879	38890	31589		64.37	44385	318.26	145000		
	26.14	77584	77581	77572	77556	47879	38890	31589		53.56	46902	279.83	145000		
	30.56	78676	72150	72147	72142	47278	38402	31192		45.81	48535	247.68	120000		
	37.50	68715	62463	60861	56239	46408	37695	30618		37.33	48401	201.27	94000		
	53.06	76163	76160	76151	64246	39642	32199	26154		26.39	48022	144.24	145000		
3	58.55	76001	75998	75989	68829	42470	34496	28020	1400	23.91	52990	144.21	145000		
	69.00	75749	75746	75737	68270	42125	34216	27792		20.29	55214	127.51	145000		
	76.11	75607	75604	75595	75581	47879	38890	31589		18.39	64630	135.28	145000		
	80.67	78676	72150	72147	72142	46993	38170	31004		17.35	64550	127.47	120000		
	89.70	75385	75382	75374	75359	47879	38890	31589		15.61	67895	120.63	145000		
	101.04	78676	72150	72147	72142	45679	37103	30137		13.86	67130	105.90	120000		
	107.81	75157	75155	75146	75131	47879	38890	31589		12.99	71746	106.08	145000		
	112.35	75109	75106	75097	75083	47879	38890	31589		12.46	72639	103.01	145000		
	130.47	74942	74939	74930	74916	47879	38890	31589		10.73	74914	91.49	145000		
	156.82	74753	74750	74741	74727	47879	38890	31589		8.93	74730	75.95	145000		
	189.49	74576	74573	74564	74550	47879	38890	31589		7.39	74557	62.71	145000		
	221.53	78676	72150	72147	71635	47278	38402	31192		6.32	72146	51.90	120000		
	271.88	68715	62463	59019	54537	45400	37695	30618		5.15	58822	34.48	94000		
	4	210.76	74483	74480	74472	68829	42470	34496		28020	1400	6.64	74467	58.18	145000
		248.40	74350	74347	74338	68270	42125	34216		27792		5.64	74336	49.33	145000
		273.99	74275	74272	74264	74249	47879	38890		31589		5.11	74263	44.65	145000
		293.25	74226	74223	74214	68270	42125	34216		27792		4.77	74215	41.65	145000
		323.46	74157	74154	74145	74131	47879	38890		31589		4.33	74147	37.77	145000
		368.00	74072	74069	74060	68270	42125	34216		27792		3.80	74064	33.11	145000
		381.23	74049	74046	74038	74023	47879	38890		31589		3.67	74042	31.97	145000
405.92		74010	74008	73999	73984	47879	38890	31589	3.45	74003		30.04	145000		
427.80		73979	73976	73967	68270	42125	34216	27792	3.27	73972		28.46	145000		
460.93		73935	73933	73924	66361	40947	33259	27015	3.04	73930		26.44	145000		
517.50		73871	73868	73860	68270	42125	34216	27792	2.71	73866		23.55	145000		
556.14		73833	73830	73821	73807	47879	38890	31589	2.52	73829		21.89	145000		
622.25		73776	73773	73765	64900	40046	32527	26420	2.25	73772		19.53	145000		
695.85		73723	73720	73711	73697	47879	38890	31589	2.01	73720		17.43	145000		
752.73		73687	73684	73675	64900	40046	32527	26420	1.86	73684		16.12	145000		
814.36		78676	72150	72147	70918	47278	38402	31192	1.72	73946		14.96	120000		
880.00		78676	72150	72147	70888	44673	36286	29473	1.59	74605		13.96	120000		
945.71		78676	72150	72147	70861	47278	38402	31192	1.48	75222		13.10	120000		
985.11		78676	72150	72147	70847	47278	38402	31192	1.42	75574		12.63	120000		
1144.00		78676	72150	72147	70795	47278	38402	31192	1.22	76879		11.04	120000		
1382.33		78676	72150	72147	70736	47278	38402	31192	1.01	78562		9.34	120000		
1661.46		78676	72150	72147	70683	47278	38402	31192	0.84	80233		7.93	120000		
2039.06		68715	62463	58326	53897	44866	37695	30618	0.69	71737		5.82	94000		

5-6 5,6 stadi/stages/stufen
A richiesta / On request / Auf Anfrage

P _{tn}	PS PSB	S-SB-SU FS-FSR
6501	117.0	65.2
6502	73.5	51.3
6503	48.8	35.8
6504	38.6	28.8

1.2 Prestazioni

1.2 Performances

1.2 Leistungen

		n ₂ X h								10000 Hours Life				T _{max} [Nm]	
		T _N [Nm]								n ₁ [rpm]	n ₂ [rpm]	T _N [Nm]	P ₁ [kW]		
Stadio Stage Stufe	ir	10000	20000	50000	100000	500000	1000000	2000000							
3	38.34	64353	64341	64304	64244	47879	38890	31589	1400	36.52	52613	223.55	145000		
	42.31	71009	70994	70950	70876	47879	38890	31589		33.09	54192	208.63	145000		
	49.46	78676	72150	72147	72142	47278	38402	31192		28.31	56077	184.71	120000		
	55.00	76103	76100	76091	76076	47879	38890	31589		25.45	58628	173.60	145000		
	66.11	75813	75810	75801	75786	47879	38890	31589		21.18	61955	152.67	145000		
	77.29	78676	72150	72147	72142	47278	38402	31192		18.11	64113	135.09	120000		
	90.61	75372	75369	75360	74776	47879	38890	31589		15.45	68101	122.42	145000		
	105.93	78676	72150	72147	72142	47278	38402	31192		13.22	70043	107.73	120000		
	127.31	78676	72150	72147	72114	47278	38402	31192		11.00	71337	91.30	120000		
	156.25	68715	62463	59368	54860	45668	37695	30618		8.96	55550	57.91	94000		
	210.49	68521	63318	57041	53877	47278	38402	31192		6.65	55216	42.72	120000		
	258.33	68715	62463	59047	54563	45421	37695	30618		5.42	58508	36.90	94000		
	4	134.20	74912	74909	74900	64246	39642	32199		26154	1400	10.43	63435	78.73	145000
		148.09	74810	74807	74798	68829	42470	34496		28020		9.45	69999	78.71	145000
174.53		74651	74648	74639	68270	42125	34216	27792	8.02	72938		69.61	145000		
192.51		74562	74559	74550	74536	47879	38890	31589	7.27	74543		64.48	145000		
226.89		74422	74419	74410	74396	47879	38890	31589	6.17	74407		54.63	145000		
253.86		74333	74330	74321	64900	40046	32527	26420	5.51	74320		48.73	145000		
287.50		74240	74237	74228	68270	42125	34216	27792	4.87	74229		43.01	145000		
326.34		74151	74148	74139	61942	38221	31045	25216	4.29	74141		37.85	145000		
360.10		74086	74083	74074	66361	40947	33259	27015	3.89	74077		34.29	145000		
396.66		74025	74022	74013	73999	47879	38890	31589	3.53	74017		31.09	145000		
418.18		73992	73990	73981	64900	40046	32527	26420	3.35	73986		29.49	145000		
468.13		73927	73924	73915	73901	47879	38890	31589	2.99	73921		26.30	145000		
543.64		73845	73842	73833	73819	47879	38890	31589	2.58	73840		22.67	145000		
656.89		73750	73747	73738	73724	47668	38719	31449	2.13	73747		18.69	145000		
691.39		73726	73723	72316	64900	40046	32527	26420	2.02	73723		17.72	145000		
789.54		73666	73663	73654	73640	47879	38890	31589	1.77	73663		15.51	145000		
898.81		73611	73608	73599	73585	47879	38890	31589	1.56	73609		13.66	145000		
923.03		78676	72150	72147	70870	47278	38402	31192	1.52	75013		13.57	120000		
976.69		78676	72150	68198	66868	44255	35946	29197	1.43	75500		12.85	120000		
1087.55		78676	72150	72147	70812	47278	38402	31192	1.29	76435		11.73	120000		
1269.70		78676	72150	72147	70762	47278	38402	31192	1.10	77801		10.18	120000		
1526.08		78676	72150	72147	70707	47278	38402	31192	0.92	79456		8.70	120000		
1872.92		68715	62463	58343	53913	44880	37695	30618	0.75	71042		6.34	94000		



P _{tn}	PS PSB	S-SB-SU FS-FSR
6503	40.4	31.8
6504	32.2	25.2

1.2 Prestazioni

1.2 Performances

1.2 Leistungen

EX		$n_2 \times h$								10000 Hours Life				T_{max} [Nm]			
		T_N [Nm]								n_1 [rpm]	n_2 [rpm]	T_N [Nm]	P_1 [kW]				
Stadio Stage Stufe	ir	10000	20000	50000	100000	500000	1000000	2000000									
2	15.16	100594	93134	93130	90186	55648	45200	36714	1400	92.35	46293	476.23	190000				
	16.73	100594	93134	93130	88850	54823	44530	36170						83.68	46975	437.88	190000
	19.56	92029	84396	84392	84386	56404	45814	37213						71.57	50649	403.80	163000
	21.75	100594	93134	93130	87542	54016	43875	35637						64.37	50074	359.06	190000
	26.14	100594	93134	86863	80267	52987	43039	34958						53.56	51905	309.68	190000
	30.56	92029	84396	84392	84079	56404	45814	37213						45.81	57904	295.49	163000
	37.50	84769	77056	76004	70233	55535	45108	36639						37.33	60444	251.35	124000
3	53.06	100594	93134	93130	88066	54340	44138	35851	1400	26.39	65826	197.72	190000				
	62.03	92029	84396	84392	82676	56404	45814	37213						22.57	71605	183.94	163000
	68.44	92029	84396	84392	82516	56404	45814	37213						20.46	73749	171.74	163000
	76.11	100594	93134	93130	87542	54016	43875	35637						18.39	72914	152.62	190000
	80.67	92029	84396	84392	82266	56404	45814	37213						17.35	77258	152.56	163000
	89.70	100594	93134	93130	87542	54016	43875	35637						15.61	76597	136.09	190000
	100.36	100594	93134	93130	88850	54823	44530	36170						13.95	80405	127.66	190000
	112.35	100594	93134	93130	87542	54016	43875	35637						12.46	81950	116.22	190000
	121.27	100594	93134	87605	85639	54379	44170	35877						11.54	84414	110.87	190000
	130.47	100594	93134	93130	87542	54016	43875	35637						10.73	85710	104.67	190000
	157.65	100594	93134	93130	87542	54016	43875	35637						8.88	90716	91.69	190000
	184.31	92029	84396	84392	81274	56404	45814	37213						7.60	83861	72.54	163000
	221.53	92029	84396	84392	81103	56404	45814	37213						6.32	84391	60.70	163000
	271.88	84769	77056	73609	68019	55535	45108	36639						5.15	73363	43.00	124000
4	191.00	100594	93134	93130	88066	54340	44138	35851	1400	7.33	93127	80.31	190000				
	225.49	100594	93134	93130	88066	54340	44138	35851						6.21	93128	68.04	190000
	248.40	100594	93134	93130	88850	54823	44530	36170						5.64	93129	61.80	190000
	265.76	100594	93134	93130	87351	53899	43779	35560						5.27	93130	57.74	190000
	293.25	100594	93134	93130	88850	54823	44530	36170						4.77	93130	52.27	190000
	322.92	100594	93134	93130	87542	54016	43875	35637						4.34	93131	47.55	190000
	368.00	100594	93134	93130	88850	54823	44530	36170						3.80	93132	41.64	190000
	397.93	100594	93134	93130	88066	54340	44138	35851						3.52	93132	38.57	190000
	427.80	100594	93134	93130	88850	54823	44530	36170						3.27	93132	35.83	190000
	460.93	100594	93134	93130	88850	54823	44530	36170						3.04	93133	33.31	190000
	485.60	100594	93134	93130	84909	52392	42555	34566						2.88	93133	31.56	190000
	535.27	100594	93134	93130	88850	54823	44530	36170						2.62	93133	28.71	190000
	622.25	100594	93134	93130	88850	54823	44530	36170						2.25	93134	24.65	190000
	696.58	100594	93134	93130	87542	54016	43875	35637						2.01	93134	22.02	190000
	808.93	100594	93134	93130	87542	54016	43875	35637						1.73	93135	18.96	190000
	909.55	100020	92425	83262	81394	54379	44170	35877						1.54	95224	17.25	190000
	978.55	100594	93134	93130	87542	54016	43875	35637						1.43	96554	16.24	190000
	1176.14	95684	88418	79652	73604	52987	43039	34958						1.19	93803	13.13	190000
	1421.16	95542	88287	79534	73494	52987	43039	34958						0.99	95705	11.15	190000
	1661.46	92029	84396	84392	79978	56404	45814	37213						0.84	93850	9.28	163000
	2039.06	84769	77056	72707	67185	55535	45108	36639						0.69	88496	7.18	124000

5-6

5,6 stadi/stages/stufen
A richiesta / On request / Auf Anfrage

P_{TN}	PS PSB	S-SB-SU FS-FSR
8002	91.9	57.7
8003	60.0	40.0
8004	47.3	32.4

1.2 Prestazioni

1.2 Performances

1.2 Leistungen

EXB		n ₂ X h								10000 Hours Life				T _{max} [Nm]			
Stadio Stage Stufe	ir	T _N [Nm]								n ₁ [rpm]	n ₂ [rpm]	T _N [Nm]	P ₁ [kW]				
		10000	20000	50000	100000	500000	1000000	2000000									
3	38.34	64353	64341	64304	64244	55648	45200	36714	1400	36.52	61150	259.83	190000				
	42.31	71009	70994	70950	70876	54823	44530	36170						33.09	62051	238.89	190000
	49.46	83012	82992	82932	82831	56404	45814	37213						28.31	66902	220.36	163000
	55.00	92305	92281	92206	87542	54016	43875	35637						25.45	66143	195.85	190000
	66.11	100594	93043	83819	77454	52987	43039	34958						21.18	68564	168.96	190000
	77.29	92029	84396	84392	82329	56404	45814	37213						18.11	76489	161.17	163000
	90.61	81402	81393	80921	74776	54016	43875	35637						15.45	71159	127.91	190000
	105.93	92029	84396	84392	81893	56404	45814	37213						13.22	79332	122.02	163000
	127.31	92029	84396	84392	81669	56404	45814	37213						11.00	80789	103.39	163000
	156.25	84769	77056	74063	68439	55535	45108	36639						8.96	69301	72.24	124000
	210.49	68521	63318	57041	53877	49130	45814	37213						6.65	55216	42.72	163000
	258.33	82155	75916	68390	65784	55535	45108	36639						5.42	67765	42.73	124000
	4	134.20	91824	91763	91582	88066	54340	44138						35851	1400	10.43	86955
148.09		100594	93134	93130	88850	54823	44530	36170	9.45	90360	101.61	190000					
174.53		100594	93134	93130	88850	54823	44530	36170	8.02	93126	88.87	190000					
192.51		100594	93134	93130	87542	54016	43875	35637	7.27	93127	80.56	190000					
226.89		100594	93134	93130	87542	54016	43875	35637	6.17	93128	68.37	190000					
253.86		100594	93134	93130	88850	54823	44530	36170	5.51	93129	61.06	190000					
287.50		100594	93134	90146	87499	54823	44530	36170	4.87	90418	52.40	190000					
326.34		100594	93134	93130	84909	52392	42555	34566	4.29	93131	47.54	190000					
360.10		100594	93134	93130	88850	54823	44530	36170	3.89	93132	43.11	190000					
398.77		100594	93134	93130	87542	54016	43875	35637	3.51	93132	38.90	190000					
418.18		100594	93134	93130	88850	54823	44530	36170	3.35	93132	37.12	190000					
468.13		100594	93134	93130	87542	54016	43875	35637	2.99	93133	33.14	190000					
543.64		100594	93134	93130	87542	54016	43875	35637	2.58	93133	28.59	190000					
656.89		100594	93134	93130	87542	54016	43875	35637	2.13	93134	23.60	190000					
691.39		81493	75304	72316	69646	54823	44530	36170	2.02	75198	18.07	190000					
789.54		96031	88738	79941	73870	52987	43039	34958	1.77	89964	18.95	190000					
898.81		100594	93134	92963	87542	54016	43875	35637	1.56	95619	17.75	190000					
930.26		95880	88599	79815	73754	52987	43039	34958	1.50	91516	16.33	190000					
976.69		92029	84396	84392	80175	56404	45814	37213	1.43	88314	15.03	163000					
1086.06		100594	93134	93130	87542	54016	43875	35637	1.29	97713	15.00	190000					
1305.37		95604	88344	79586	73542	52987	43039	34958	1.07	94845	12.08	190000					
1526.08		92029	84396	84392	80006	56404	45814	37213	0.92	92942	10.17	163000					
1872.92		84769	77056	72729	67206	55535	45108	36639	0.75	87640	7.82	124000					



P _{TN}	PS PSB	S-SB-SU FS-FSR
8003	47.9	34.6
8004	38.6	27.7



1.2 Prestazioni

1.2 Performances

1.2 Leistungen

EX		n ₂ X h							10000 Hours Life				T _{max} [Nm]				
Stadio Stage Stufe	ir	T _N [Nm]							n ₁ [rpm]	n ₂ [rpm]	T _N [Nm]	P ₁ [kW]					
		10000	20000	50000	100000	500000	1000000	2000000									
1	4.18	100594	93134	93130	93123	57729	46890	38087	1000	239.23	36094	932.13	190000				
	4.89	92029	84396	84392	84386	56404	45814	37213						166.67	38699	696.28	124000
	6.00	84769	77056	77053	75158	55535	45108	36639									
2	14.72	100594	93134	93130	93123	57729	46890	38087	1400	95.11	47601	504.33	190000				
	16.73	100594	93134	93130	93123	57729	46890	38087						83.68	49464	461.08	190000
	19.68	100594	93134	93130	93123	57729	46890	38087									
	24.45	100594	93134	93130	93123	57729	46890	38087									
	28.58	92029	84396	84392	84238	56404	45814	37213									
	35.08	84769	77056	76132	70351	55535	45108	36639									
3	51.52	100594	93134	93130	86273	53233	43239	35121	1400	27.17	63919	197.66	190000				
	58.55	100594	93134	93130	93123	57729	46890	38087						23.91	72028	196.02	190000
	68.88	100594	93134	93130	93123	57729	46890	38087									
	76.05	100594	93134	93130	83179	51325	41688	33862									
	81.18	100594	93134	93130	93123	57729	46890	38087									
	86.42	100594	93134	93130	90966	56129	45591	37031									
	101.68	100594	93134	93130	93123	57729	46890	38087									
	118.07	100594	93134	93130	93123	57729	46890	38087									
	126.31	100594	93134	93130	93123	57729	46890	38087									
	146.69	100594	93134	93130	93123	57729	46890	38087									
	166.80	92029	84396	84392	81373	56404	45814	37213									
	177.24	100594	93134	93130	93123	57729	46890	38087									
	207.21	92029	84396	84392	81164	56404	45814	37213									
	254.31	84769	77056	73658	68064	55535	45108	36639									
4	185.47	100594	93134	93130	86273	53233	43239	35121	1400	7.55	93127	82.72	190000				
	210.76	100594	93134	93130	93123	57729	46890	38087						6.64	93128	72.75	190000
	247.96	100594	93134	93130	93123	57729	46890	38087									
	274.77	100594	93134	93130	86273	53233	43239	35121									
	292.24	100594	93134	93130	93123	57729	46890	38087									
	323.84	100594	93134	93130	85572	52801	42888	34836									
	367.34	100594	93134	93130	93123	57729	46890	38087									
	405.62	100594	93134	93130	83179	51325	41688	33862									
	432.94	100594	93134	93130	93123	57729	46890	38087									
	460.93	100594	93134	93130	90966	56129	45591	37031									
	503.29	100594	93134	93130	93123	57729	46890	38087									
	542.27	100594	93134	93130	93123	57729	46890	38087									
	630.39	100594	93134	93130	93123	57729	46890	38087									
	732.06	100594	93134	93130	93123	57729	46890	38087									
	762.57	100594	93134	93130	93123	57729	46890	38087									
	885.56	100594	93134	93130	93123	57729	46890	38087									
	947.34	100594	93134	93130	93123	57729	46890	38087									
	1100.14	100594	93134	93130	93123	57729	46890	38087									
	1329.34	100594	93134	93130	93123	57729	46890	38087									
	1554.10	92029	84396	84392	80000	56404	45814	37213									
	1907.31	84769	77056	72724	67202	55535	45108	36639									
5-6	5,6 stadi/stages/stufen A richiesta / On request / Auf Anfrage																
	P _{TN}	PS PSB						S-SB-SU FS-FSR									
8501	159.9						80.1										
8502	91.9						57.7										
8503	60.0						40.0										
8504	47.3						32.4										

1.2 Prestazioni

1.2 Performances

1.2 Leistungen

EXB		n ₂ X h							10000 Hours Life				T _{max} [Nm]
Stadio Stage Stufe	ir	T _N [Nm]							n ₁ [rpm]	n ₂ [rpm]	T _N [Nm]	P ₁ [kW]	
		10000	20000	50000	100000	500000	1000000	2000000					
3	37.23	62489	62478	62444	62387	57729	46890	38087	1400	37.60	62072	271.54	190000
	42.31	71009	70994	70950	70876	57729	46890	38087		33.09	65340	251.55	190000
	49.78	83536	83516	83455	83353	57729	46890	38087		28.12	68606	224.46	190000
	61.84	100594	93134	93130	93123	57729	46890	38087		22.64	73219	192.87	190000
	72.29	92029	84396	84392	82431	56404	45814	37213		19.37	74970	168.96	163000
	82.00	73668	73660	73639	68445	57729	46890	38087		17.07	64398	127.90	190000
	95.86	86122	84396	84392	78606	56404	45814	37213		14.60	75286	127.89	163000
	101.86	91516	91505	89770	82953	57729	46890	38087		13.74	80001	127.89	190000
	119.09	92029	84396	84392	81748	56404	45814	37213		11.76	80255	109.81	163000
	146.15	84769	77056	74127	68498	55535	45108	36639		9.58	68834	76.72	124000
	168.42	56235	51965	46813	43301	40242	36657	36657		8.31	44179	42.71	190000
	196.89	64584	59679	53763	50469	46307	42855	37213		7.11	51648	42.72	163000
	241.64	77433	71553	64460	61643	55420	45108	36639		5.79	63387	42.70	124000
	4	130.32	89166	89109	88938	86273	53233	43239		35121	1400	10.74	84438
148.09		100594	93134	93130	93123	57729	46890	38087	9.45	93124		104.71	190000
174.53		100594	93134	93130	93123	57729	46890	38087	8.02	93126		88.87	190000
205.33		100594	93134	93130	93123	57729	46890	38087	6.82	93128		75.58	190000
218.60		100594	93134	93130	90966	56129	45591	37031	6.40	93128		70.92	190000
253.86		100594	93134	93130	88963	54893	44587	36216	5.51	93129		61.06	190000
298.66		100594	93134	93130	93123	57729	46890	38087	4.69	93131		51.97	190000
338.24		100594	93134	93130	93123	57729	46890	38087	4.14	93131		45.88	190000
360.10		100594	93134	93130	90966	56129	45591	37031	3.89	93132		43.11	190000
418.18		100594	93134	93130	88963	54893	44587	36216	3.35	93132		37.12	190000
491.98		100594	93134	93130	93123	57729	46890	38087	2.85	93133		31.58	190000
526.30		100594	93134	93130	93123	57729	46890	38087	2.66	93133		29.48	190000
594.47		100594	93134	93130	93123	57729	46890	38087	2.36	93134		26.15	190000
611.19		100594	93134	93130	93123	57729	46890	38087	2.29	93134		25.38	190000
694.99		92029	84396	84392	80332	56404	45814	37213	2.01	84396		20.19	163000
738.52		100594	93134	93130	93123	57729	46890	38087	1.90	93134		21.06	190000
870.15		99910	92706	90139	85939	57729	46890	38087	1.61	94641		18.13	190000
982.86		100594	93134	93130	93123	57729	46890	38087	1.42	96602		16.32	190000
1010.50		100594	93134	93130	93123	57729	46890	38087	1.39	96909		16.03	190000
1149.05		92029	84396	84392	80109	56404	45814	37213	1.22	89972		13.06	163000
1221.02		100594	93134	93130	93123	57729	46890	38087	1.15	99031		13.55	190000
1427.47		92029	84396	84392	80029	56404	45814	37213	0.98	92234		10.76	163000
1751.90		84769	77056	72748	67223	55535	45108	36639	0.80	86972		8.28	124000



P _{TN}	PS PSB	S-SB-SU FS-FSR
8503	47.9	34.6
8504	38.6	27.7

1.2 Prestazioni

1.2 Performances

1.2 Leistungen

EX 	n ₂ X h								10000 Hours Life				T _{max} [Nm]		
	Stadio Stage Stufe	ir	T _N [Nm]								n ₁ [rpm]	n ₂ [rpm]		T _N [Nm]	P ₁ [kW]
			10000	20000	50000	100000	500000	1000000	2000000						
1	4.04	136727	126588	126583	116355	71795	58315	47367	500	123.76	54702	730.82	235000		
	5.12	117651	107409	107405	107398	69871	56753	46098		97.66	57158	602.59	195000		
	6.00	104866	95324	95321	95315	68869	55939	45437		83.33	59084	531.49	170000		
	7.36	91673	84711	76313	70518	58703	54948	44642		67.93	54324	398.36	135000		
2	14.23	136727	126588	126583	116355	71795	58315	47367	1400	98.38	58601	642.22	235000		
	16.17	136727	126588	126583	115709	71396	57992	47104		86.58	60554	584.02	235000		
	19.03	136727	126588	126583	112595	69475	56431	45837		73.57	61875	507.09	235000		
	20.47	117651	107409	107405	104210	69871	56753	46098		68.39	63604	484.56	195000		
	23.64	129278	119461	107618	99446	68938	55995	45482		59.22	65525	432.26	235000		
	29.92	117651	107409	107405	102939	69871	56753	46098		46.79	71276	371.51	195000		
	35.08	104866	95324	95321	92667	68869	55939	45437		39.91	73688	327.60	170000		
	43.05	85990	79460	71583	66147	55064	51542	44642		32.52	57830	209.49	135000		
	49.82	136727	126588	103742	84265	51994	42232	34303		28.10	61806	197.67	235000		
	56.61	136727	126588	113453	92153	56861	46186	37515		24.73	70232	197.68	235000		
3	66.60	136727	126588	125052	103256	63712	51751	42035	1400	21.02	82626	197.68	235000		
	71.65	117651	107409	107405	100742	67056	54466	44240		19.54	88891	197.69	195000		
	73.54	136727	126588	100023	81244	50130	40718	33074		19.04	66974	145.14	235000		
	78.49	136727	126588	124416	102418	63195	51330	41693		17.84	86095	174.82	235000		
	84.29	117651	107409	107405	100426	69871	56753	46098		16.61	94785	179.19	195000		
	98.31	136727	126588	122565	99554	61428	49895	40527		14.24	89536	145.12	235000		
	99.34	117651	107409	107405	100131	69871	56753	46098		14.09	96292	154.42	195000		
	105.76	117651	107409	107405	100024	64652	52514	42654		13.24	96323	145.15	195000		
	114.17	136727	126588	119867	97362	60076	48797	39635		12.26	91583	127.80	235000		
	122.13	122117	112843	101656	93937	68938	55995	45482		11.46	92486	120.63	235000		
	124.43	117651	107409	107405	99763	69871	56753	46098		11.25	98432	126.04	195000		
	141.83	121692	112451	101303	93610	68938	55995	45482		9.87	93749	105.32	235000		
	154.58	117651	107409	107405	99445	69871	56753	46098		9.06	100574	103.71	195000		
	179.51	117651	107409	107402	99246	69871	56753	46098		7.80	102097	90.64	195000		
	216.91	117651	107409	107150	99013	69871	56753	46098		6.45	104078	76.41	195000		
	254.31	104866	95324	95321	89433	68869	55939	45437		5.51	95320	59.78	170000		
	312.10	83306	76979	69348	64082	53345	49933	44642		4.49	70211	35.88	135000		
	179.34	136727	126588	103742	84265	51994	42232	34303		7.81	90763	83.40	235000		
	203.79	136727	126588	113453	92153	56861	46186	37515		6.87	103139	83.37	235000		
	239.75	136727	126588	121182	103256	63712	51751	42035		5.84	119058	81.80	235000		
283.04	136727	126588	120834	103256	63712	51751	42035	4.95	120982	70.46	235000				
333.59	136727	126588	120516	102418	63195	51330	41693	4.20	122945	60.75	235000				
355.19	136727	126588	120401	103256	63712	51751	42035	3.94	123709	57.35	235000				
413.65	136727	126588	112532	91405	56400	45811	37210	3.38	126508	50.31	235000				
445.68	136727	126588	109386	88849	54823	44530	36169	3.14	125753	46.46	235000				
486.64	136727	126588	119876	102418	63195	51330	41693	2.88	126587	42.89	235000				
524.33	136727	126588	119763	99554	61428	49895	40527	2.67	126587	39.77	235000				
609.53	136727	126588	119548	99554	61428	49895	40527	2.30	126588	34.26	235000				
707.85	136727	126588	119350	97362	60076	48797	39635	1.98	126588	29.49	235000				
856.27	136727	126588	119118	97362	60076	48797	39635	1.63	129247	24.79	235000				
916.00	118348	109361	98519	91037	68938	55995	45482	1.53	112763	20.30	235000				
1063.75	118191	109216	98388	90917	68938	55995	45482	1.32	114549	17.79	235000				
1159.34	117651	107409	105710	97683	69871	56753	46098	1.21	115138	16.39	195000				
1285.36	118008	109047	98236	90776	68938	55995	45482	1.09	116865	14.99	235000				
1346.33	117651	107409	105631	97610	69871	56753	46098	1.04	117125	14.33	195000				
1626.82	117651	107409	105540	97525	69871	56753	46098	0.86	119690	12.11	195000				
1907.31	104866	95324	95321	88211	68869	55939	45437	0.73	108643	9.33	170000				
2340.79	82294	76045	68506	63304	52697	49327	44642	0.60	87594	6.18	135000				

5-6 5,6 stadi/stages/stufen
A richiesta / On request / Auf Anfrage

P _{EN}	PS PSB	S-SB-SU FS-FSR
10001	169.7	99.7
10002	96.1	66.1
10003	62.4	44.9
10004	49.2	36.0

1.2 Prestazioni

1.2 Performances

1.2 Leistungen

 Stadio Stage Stufe		n ₂ X h							10000 Hours Life				T _{max} [Nm]	
		T _N [Nm]							n ₁ [rpm]	n ₂ [rpm]	T _N [Nm]	P ₁ [kW]		
ir	10000	20000	50000	100000	500000	1000000	2000000							
3	36.00	60422	60412	60380	60326	59900	58315	47367	1400		38.89	60019	271.57	235000
	40.91	68660	68646	68605	68536	67986	57992	47104			34.22	68203	271.54	235000
	48.13	80774	80755	80697	80602	69475	56431	45837			29.09	80239	271.57	235000
	51.78	86895	86873	86807	86697	69871	56753	46098			27.04	84023	264.34	195000
	60.92	102225	102195	102103	101084	69871	56753	46098			22.98	88223	235.88	195000
	75.68	117651	107409	107405	100633	69871	56753	46098			18.50	93821	201.94	195000
	88.72	104866	95324	95321	90765	68869	55939	45437			15.78	86168	158.20	170000
	100.35	90151	90141	88583	81856	69871	56753	46098			13.95	78809	127.91	195000
	117.65	104866	95324	95321	90337	68869	55939	45437			11.90	88565	122.62	170000
	124.66	111992	107409	107360	99208	69871	56753	46098			11.23	97904	127.92	195000
	146.15	104866	95324	95321	90047	68869	55939	45437			9.58	90489	100.86	170000
	179.37	83814	77449	69771	64473	53671	50238	44642			7.81	66319	60.26	135000
	194.51	63890	59039	53186	49871	45807	42337	42337			7.20	51023	42.74	170000
	241.64	77433	71553	64460	61643	55420	52595	45437			5.79	63387	42.70	170000
	296.56	83347	77018	69382	64113	53371	49958	44642			4.72	69838	38.35	135000
4	126.00	86218	86164	86005	84265	51994	42232	34303	1400		11.11	81643	107.93	235000
	143.19	97966	97898	97691	92153	56861	46186	37515			9.78	92778	107.97	235000
	168.76	115446	115350	112532	91405	56400	45811	37210			8.30	96674	95.48	235000
	198.54	135799	126588	121614	102418	63195	51330	41693			7.05	113734	95.41	235000
	211.37	136727	126588	109386	88849	54823	44530	36169			6.62	100537	79.20	235000
	248.67	136727	126588	121103	99554	61428	49895	40527			5.63	118279	79.24	235000
	288.78	136727	126588	119867	97362	60076	48797	39635			4.85	120982	69.82	235000
	327.05	119161	112171	101051	99112	63195	51330	41693			4.28	102855	52.38	235000
	348.19	126861	118573	107265	88849	54823	44530	36169			4.02	109504	52.38	235000
	409.63	136727	126588	120153	99554	61428	49895	40527			3.42	125476	51.06	235000
	475.70	136727	126588	119867	97362	60076	48797	39635			2.94	126587	44.28	235000
	518.45	117651	107409	106254	98185	69871	56753	46098			2.70	107408	34.51	195000
	574.81	113292	104689	94924	93123	59513	48340	39264			2.44	102364	29.72	235000
	602.08	117651	107409	106136	98076	69871	56753	46098			2.33	107408	29.78	195000
	644.08	117651	107409	106085	98029	69871	56753	46098			2.17	107409	27.73	195000
	714.09	118636	109627	98759	91260	68938	55995	45482			1.96	109877	25.63	235000
	852.94	104866	95324	95321	88559	68869	55939	45437			1.64	99084	19.34	170000
	903.79	117651	107409	105856	97817	69871	56753	46098			1.55	111903	20.64	195000
	1064.88	117651	107409	105758	97727	69871	56753	46098			1.31	114024	17.77	195000
	1180.63	118088	109121	98303	90838	68938	55995	45482			1.19	115817	16.40	235000
	1236.63	117651	107409	105676	97651	69871	56753	46098			1.13	115992	15.60	195000
	1449.85	104866	95324	95321	88314	68869	55939	45437			0.97	105286	12.15	170000
	1751.90	104866	95324	95321	88241	68869	55939	45437			0.80	107591	10.24	170000
	2150.06	82319	76068	68527	63323	52713	49342	44642			0.65	86501	6.69	135000



P _{TN}	PS PSB	S-SB-SU FS-FSR
10003	49.6	37.9
10004	40.0	30.4

1.2 Prestazioni

1.2 Performances

1.2 Leistungen

EX		n ₂ X h							10000 Hours Life				T _{max} [Nm]																																																																															
Stadio Stage Stufe	ir	T _N [Nm]							n ₁ [rpm]	n ₂ [rpm]	T _N [Nm]	P ₁ [kW]																																																																																
		10000	20000	50000	100000	500000	1000000	2000000																																																																																				
1	4.18	157301	145637	145630	145619	94974	77143	62660	500	119.62	73107	944.03	295000																																																																															
	4.89	141623	129876	129870	129862	93288	75773	61547						102.25	75269	830.82	250000																																																																											
	6.00	127109	115544	115539	115532	91825	74585	60582										83.33	78779	708.66	184000																																																																							
2	16.91	157301	145637	145630	122263	75441	61277	49772	1400	82.79	64849	598.07	295000																																																																															
	19.77	141623	129876	129870	129862	84158	68358	55524						70.81	75814	598.02	250000																																																																											
	21.40	157301	145637	145630	119870	73964	60077	48798										65.42	68233	497.25	295000																																																																							
	25.09	157301	145637	140077	117487	72494	58883	47828														55.80	70146	436.02	295000																																																																			
	29.33	141623	129876	129870	129862	80871	65688	53355																		47.73	82005	436.01	250000																																																															
	36.00	137481	127041	114446	105755	80066	65033	52824																						38.89	86335	374.02	250000																																																											
	44.18	127109	115544	115539	107855	89784	74585	60582																										31.69	94573	333.86	184000																																																							
	59.18	155135	145637	117039	95065	58658	47646	38700																														1400	23.66	73424	197.72	295000																																																		
69.75	154560	145637	116089	94293	58182	47259	38386	20.07	76508	174.77	295000																																																																																	
74.90	154325	145637	138023	112110	69175	56188	45639					18.69	92928	197.68	295000																																																																													
87.82	153828	145637	133502	117487	72494	58883	47828									15.94	102148	185.32	295000																																																																									
103.50	153355	145637	132877	117487	72494	58883	47828													13.53	107309	165.25	295000																																																																					
110.57	153176	145637	133074	108090	66695	54173	44002																	12.66	100702	145.10	295000																																																																	
128.41	152790	145637	130145	105710	65227	52981	43034																					10.90	103005	127.79	295000																																																													
150.55	152410	145637	131621	117487	72494	58883	47828																									9.30	120076	127.10	295000																																																									
181.91	150728	139282	129544	117055	72227	58666	47652																													7.70	124782						109.36	295000																																																
212.67	141623	129876	129870	129528	80573	65446	53158																																						6.58	129868	97.26	250000																																												
261.00	127109	115544	113291	104688	87148	74585	60582																																										5.36	112388	68.56	184000																																								
320.32	127109	115544	113057	104472	86968	74585	60582																																														4.37	114803	57.10	184000																																				
213.05	151679	145637	117039	95065	58658	47646	38700																																																		1400	6.57	107827	83.35	295000																															
251.10	151374	145637	116089	94293	58182	47259	38386																																																							5.58	112356	73.76	295000																											
269.65	151250	145637	138023	112110	69175	56188	45639																																																											5.19	136472	83.33	295000																							
296.44	151091	145637	116089	94293	58182	47259	38386																																																															4.72	118093	65.58	295000																			
318.34	150977	145637	138023	112110	69175	56188	45639	4.40	143440	74.26	295000																																																																																	
375.19	150728	145637	136902	111199	68614	55732	45268					3.73	145633	63.91	295000																																																																													
398.06	150643	145637	133074	108090	66695	54173	44002									3.52	145633	60.31	295000																																																																									
439.88	150506	143265	129062	117487	72494	58883	47828													3.18	135879	50.84	295000																																																																					
464.40	150434	145637	138023	112110	69175	56188	45639																	3.01	145634	51.57	295000																																																																	
547.33	150228	145637	136902	111199	68614	55732	45268																					2.56	145635	43.86	295000																																																													
641.70	150044	142573	128439	117487	72494	58883	47828																									2.18	141167	36.21	295000																																																									
685.55	149972	145637	133074	108090	66695	54173	44002																													2.04	145637	34.95	295000																																																					
796.12	149817	145637	130145	105710	65227	52981	43034																																	1.76	145637	30.16	295000																																																	
829.29	149777	145637	133074	108090	66695	54173	44002																																					1.69	145637	28.96	295000																																													
933.38	149665	142003	127926	117487	72494	58883	47828																																									1.50	146736	25.90	295000																																									
972.27	149628	141948	127875	117487	72494	58883	47828																																													1.44	147362	24.97	295000																																					
1129.09	149498	141752	127700	117487	72494	58883	47828																																																	1.24																		149497	21.81	295000																
1364.32	143257	132378	123123	117055	72227	58666	47652																																																																						1.03	142836	17.31	295000												
1595.00	141623	129876	129870	127552	80573	65446	53158																																																																										0.88	143752	14.88	250000								
1988.18	127109	115544	111756	103269	85967	74585	60582																																																																														0.70	132315	10.90	184000				
2402.39	127109	115544	111677	103197	85906	74585	60582																																																																																		0.58	135212	9.23	184000

5-6

5,6 stadi/stages/stufen
A richiesta / On request / Auf Anfrage

P _{TN}	PS PSB	S-SB-SU FS-FSR
12001	169.7	99,7
12002	103.1	73,1
12003	68.9	51,4
12004	54.0	40,9

1.2 Prestazioni

1.2 Performances

1.2 Leistungen

EXB		n ₂ X h							10000 Hours Life				T _{max} [Nm]
Stadio Stage Stufe	ir	T _N [Nm]							n ₁ [rpm]	n ₂ [rpm]	T _N [Nm]	P ₁ [kW]	
		10000	20000	50000	100000	500000	1000000	2000000					
4	149.70	102416	102341	102116	95065	58658	47646	38700	1400	9.35	96995	107.91	295000
	176.43	120689	120585	116089	94293	58182	47259	38386		7.94	101068	95.49	295000
	189.46	129598	129478	129117	112110	69175	56188	45639		7.39	122761	107.95	295000
	223.29	151589	145637	136902	111199	68614	55732	45268		6.27	127916	95.43	295000
	261.79	151301	144455	130134	117487	72494	58883	47828		5.35	129141	82.21	295000
	279.68	151188	145637	133074	108090	66695	54173	44002		5.01	133029	79.30	295000
	324.79	150945	145637	130145	105710	65227	52981	43034		4.31	136069	69.78	295000
	380.79	150707	143566	129333	117487	72494	58883	47828		3.68	133944	58.65	295000
	431.25	150533	143305	129099	117487	72494	58883	47828		3.25	135610	52.44	295000
	460.72	150445	145637	133074	108090	66695	54173	44002		3.04	144894	52.41	295000
	535.03	150256	145637	130145	105710	65227	52981	43034		2.62	145635	45.40	295000
	627.27	150070	142611	128473	117487	72494	58883	47828		2.23	140840	37.37	295000
	757.95	144755	133762	124410	117055	72227	58666	47652		1.85	134980	29.71	295000
	886.11	141623	129876	129870	127940	80573	65446	53158		1.58	134400	25.27	250000
	951.14	127109	115544	112145	103628	86266	74585	60582		1.47	121608	21.27	184000
	1068.86	119884	113394	105547	103250	64616	52485	42631		1.31	116253	18.12	295000
	1253.15	138029	132421	123287	117055	72227	58666	47652		1.12	136297	18.16	295000
	1465.04	141623	129876	129870	127601	80573	65446	53158		0.96	142361	16.26	250000
	1488.00	126556	116946	105352	97352	80066	65033	52824		0.94	127438	14.25	250000
	1826.18	127109	115544	111794	103304	85996	74585	60582		0.77	131034	12.01	184000
2206.64	127109	115544	111712	103228	85933	74585	60582	0.63	133903	10.04	184000		



P_{TN}	PS PSB	S-SB-SU FS-FSR
12004	43.5	33,9

1.2 Prestazioni

1.2 Performances

1.2 Leistungen

EX		n ₂ X h								10000 Hours Life				T _{max} [Nm]
Stadio Stage Stufe	ir	T _N [Nm]								n ₁ [rpm]	n ₂ [rpm]	T _N [Nm]	P ₁ [kW]	
		10000	20000	50000	100000	500000	1000000	2000000						
2	16.35	193471	179124	147021	119418	73685	59851	48614	1400	85.63	62703	598.11	360000	
	20.69	167759	153155	153149	140828	86896	70581	57330		67.67	79356	598.20	280000	
	26.19	167759	153155	153149	138071	85195	69200	56208		53.46	83504	497.28	280000	
	30.71	167759	153155	153149	135327	83501	67824	55090		45.59	85848	435.98	280000	
	36.00	146105	132811	132806	128799	93336	75813	61579		38.89	100645	436.01	230000	
	44.18	146105	132811	132806	126797	92407	75058	60966		31.69	105956	374.04	230000	
	54.22	119076	110033	99125	91597	76250	71374	69924		25.82	82214	236.47	155000	
3	57.22	185252	150482	114315	92853	57293	46537	37799	1400	24.47	70994	197.73	360000	
	67.44	183761	149261	113387	92099	56828	46159	37493		20.76	73976	174.79	360000	
	72.43	165827	165818	134811	109500	67565	54880	44577		19.33	89857	197.69	360000	
	85.36	165827	165818	133716	108611	67017	54435	44215		16.40	93630	174.77	360000	
	91.67	167759	153155	153149	129133	79679	64720	52569		15.27	113728	197.66	280000	
	107.47	167759	153155	153149	135327	83501	67824	55090		13.03	125007	185.39	280000	
	126.66	167759	153155	153149	135327	83501	67824	55090		11.05	131322	165.16	280000	
	158.65	167759	153155	153149	135327	83501	67824	55090		8.82	140501	141.04	280000	
	184.24	167759	153155	153149	135327	83501	67824	55090		7.60	146947	127.11	280000	
	222.62	167759	153155	153149	134829	83194	67574	54887		6.29	151046	108.14	280000	
	261.00	146105	132811	132806	124076	92992	75533	61352		5.36	132805	81.02	230000	
	320.32	146105	132811	129187	119377	92407	75058	60966		4.37	131183	65.25	230000	
	393.12	115523	106751	96168	88865	73976	69244	67838		3.56	99959	40.50	155000	
	4	206.01	178445	150482	114315	92853	57293	46537		37799	1400	6.80	104261	83.41
243.20		177833	150482	114315	92853	57293	46537	37799	5.76	109584		74.26	360000	
260.73		165827	165504	134811	109500	67565	54880	44577	5.37	131958		83.37	360000	
307.81		165827	165028	134811	109500	67565	54880	44577	4.55	138695		74.25	360000	
330.00		167759	153155	153149	129133	79679	64720	52569	4.24	153151		76.40	280000	
362.78		165827	164594	133716	108611	67017	54435	44215	3.86	144521		65.63	360000	
386.27		165827	164437	134811	109500	67565	54880	44577	3.62	148472		63.24	360000	
449.04		165827	164080	134811	109500	67565	54880	44577	3.12	155333		57.02	360000	
487.14		167759	153155	153149	124503	76822	62399	50684	2.87	153153		51.71	280000	
543.19		165827	163666	134811	109500	67565	54880	44577	2.58	159004		48.27	360000	
570.21		165827	163566	129977	105574	65143	52913	42978	2.46	159789		46.25	360000	
640.19		165827	163338	133716	108611	67017	54435	44215	2.19	161685		41.66	360000	
721.69		167759	153155	153149	124503	76822	62399	50684	1.94	153155		34.96	280000	
801.86		165827	162931	129977	105574	65143	52913	42978	1.75	165473		34.07	360000	
983.61		167759	153155	153016	135327	83501	67824	55090	1.42	161117		26.92	280000	
1189.85		167759	153155	152849	135327	83501	67824	55090	1.18	164665		22.86	280000	
1381.76		167759	153155	152722	135327	83501	67824	55090	1.01	167507		19.90	280000	
1669.63		167759	153155	149827	134829	83194	67574	54887	0.84	171175		16.92	280000	
1988.18		146105	132811	126227	116642	92407	75058	60966	0.70	152089		12.53	230000	
2402.39		146105	132811	126048	116476	92407	75058	60966	0.58	155419		10.61	230000	
2948.38		114186	105515	95055	87836	73119	68443	67053	0.47	125856		6.96	155000	

5-6

5,6 stadi/stages/stufen
A richiesta / On request / Auf Anfrage

P _{TN}	PS PSB	S-SB-SU FS-FSR-SFD
15002	125.2	91.0
15003	81.8	61.8
15004	63.7	48.7

1.2 Prestazioni

1.2 Performances

1.2 Leistungen

		n ₂ X h								10000 Hours Life				T _{max} [Nm]
		T _N [Nm]								n ₁ [rpm]	n ₂ [rpm]	T _N [Nm]	P ₁ [kW]	
Stadio Stage Stufe	ir	10000	20000	50000	100000	500000	1000000	2000000						
4	144.74	99031	98960	98750	92853	57293	46537	37799	1400	9.67	93785	107.91	360000	
	170.59	116700	116602	113387	92099	56828	46159	37493		8.21	97724	95.47	360000	
	215.91	147669	147512	133716	108611	67017	54435	44215		6.48	123685	95.37	360000	
	231.86	158567	153155	153149	129133	79679	64720	52569		6.04	150233	107.97	280000	
	253.13	151735	140213	126312	114753	70807	57513	46715		5.53	124869	82.17	360000	
	273.27	167759	153155	153149	128084	79032	64194	52142		5.12	153149	93.30	280000	
	320.38	167759	153155	153149	135327	83501	67824	55090		4.37	153150	79.64	280000	
	342.27	167759	153155	153149	124503	76822	62399	50684		4.09	153151	74.53	280000	
	397.48	167759	153155	149906	121762	75131	61025	49568		3.52	153152	64.15	280000	
	445.48	159626	147504	129977	105574	65143	52913	42978		3.14	140101	52.35	360000	
	466.01	167759	153155	153149	135327	83501	67824	55090		3.00	153153	54.67	280000	
	527.76	167759	153155	153149	135327	83501	67824	55090		2.65	153154	48.29	280000	
	563.82	167759	153155	153149	124503	76822	62399	50684		2.48	153154	45.20	280000	
	625.10	122033	112766	103058	100931	63112	51263	41639		2.24	111321	29.67	360000	
	654.76	167759	153155	149906	121762	75131	61025	49568		2.14	153155	39.00	280000	
	767.65	167759	153155	153149	135327	83501	67824	55090		1.82	156610	33.92	280000	
	927.57	167759	153155	151394	134829	83194	67574	54887		1.51	160039	28.76	280000	
	1087.50	146105	132811	132718	122640	92992	75533	61352		1.29	141941	21.79	230000	
	1269.18	139592	134068	128647	119860	83501	67824	55090		1.10	138040	18.07	280000	
	1533.59	165075	153155	150027	134829	83194	67574	54887		0.91	166798	18.06	280000	
1826.18	146105	132811	126314	116722	92407	75058	60966	0.77	150617	13.80	230000			
2206.64	146105	132811	126126	116549	92407	75058	60966	0.63	153914	11.54	230000			
2708.14	114219	105546	95082	87862	73141	68463	67072	0.52	124285	7.69	155000			



P_{TN}	PS PSB	S-SB-SU FS-FSR-SFD
15004	50.5	39.6

1.2 Prestazioni

1.2 Performances

1.2 Leistungen

EX 		n ₂ X h								10000 Hours Life				T _{max} [Nm]				
Stadio Stage Stufe	ir	T _N [Nm]								n ₁ [rpm]	n ₂ [rpm]	T _N [Nm]	P ₁ [kW]					
		10000	20000	50000	100000	500000	1000000	2000000										
1	4.04	193471	179124	179116	179103	114665	93137	75651	500	123.76	87367	1167.22	360000					
	5.12	167759	153155	153149	153139	111601	90648	73629										
	6.00	146105	132811	132806	132798	110072	89406	72620										
	7.36	128092	118365	106631	98533	82024	76778	71535										
2	16.91	193471	179124	179116	159224	98247	79801	64819	1400	82.79	84453	778.86	360000					
	19.77	193471	179124	179116	156104	96321	78237	63548										
	21.40	167759	153155	153149	151072	111601	90648	73629										
	24.26	179838	170566	153657	141988	94409	76684	62287										
	30.71	167759	153155	153149	149245	111335	90432	73454										
	36.00	146105	132811	132806	128799	107219	89406	72620										
	44.18	119678	110590	99627	92061	76636	71735	70278										
	62.90	193471	179124	179116	157336	97082	78855	64050										
3	69.17	193471	179124	179116	156701	96690	78536	63791	1400	20.24	126826	292.16	360000					
	73.54	193471	179124	179116	156104	96321	78237	63548										
	80.87	193471	179124	179116	156104	96321	78237	63548										
	88.77	193471	179124	179116	152935	94366	76649	62258										
	103.78	193471	179124	179116	156104	96321	78237	63548										
	123.17	193471	179124	179116	156104	96321	78237	63548										
	155.89	167759	153155	153149	143967	111601	90648	73629										
	191.32	167759	153155	153149	143552	111335	90432	73454										
	224.31	146105	132811	132806	124298	103472	89406	72620										
	275.29	115934	107130	96510	89181	74239	69491	68079										
	226.45	193471	179124	173364	140815	86888	70575	57325						1400	6.18	162668	118.28	360000
	249.02	193471	179124	179116	150502	92865	75430	61268										
264.73	193471	179124	179116	156104	96321	78237	63548											
293.99	193471	179124	179116	148327	91523	74339	60382											
319.58	193471	179124	179116	152935	94366	76649	62258											
377.28	193471	179124	179116	152935	94366	76649	62258											
392.20	193471	179124	179116	150201	92679	75279	61146											
428.88	193471	179124	175289	142379	87853	71358	57961											
473.45	193471	179124	179116	152935	94366	76649	62258											
501.39	193471	179124	179116	156104	96321	78237	63548											
550.39	193471	179124	179116	152935	94366	76649	62258											
653.21	193471	179124	164032	149262	92100	74808	60763											
763.66	193471	179124	179116	156104	96321	78237	63548											
790.17	193471	179124	163437	149262	92100	74808	60763											
923.78	193471	179124	179116	156104	96321	78237	63548											
1020.38	167759	153155	152983	141366	111335	90432	73454											
1186.19	167759	153155	152852	141245	111335	90432	73454											
1434.91	167759	153155	152700	141104	111335	90432	73454											
1682.31	146105	132811	132426	122370	101867	89406	72620											
2064.65	114336	105653	95179	87951	73215	68533	67141											
4	6.18	193471	179124	179116	150502	92865	75430	61268	1400	5.62	178886	118.28	360000					
	5.29	193471	179124	179116	156104	96321	78237	63548										
	4.76	193471	179124	179116	148327	91523	74339	60382										
	4.38	193471	179124	179116	152935	94366	76649	62258										
	3.71	193471	179124	179116	152935	94366	76649	62258										
	3.57	193471	179124	179116	150201	92679	75279	61146										
	3.26	193471	179124	175289	142379	87853	71358	57961										
	2.96	193471	179124	179116	152935	94366	76649	62258										
	2.79	193471	179124	179116	156104	96321	78237	63548										
	2.54	193471	179124	179116	152935	94366	76649	62258										
	2.14	193471	179124	164032	149262	92100	74808	60763										
	1.83	193471	179124	179116	156104	96321	78237	63548										
	1.77	193471	179124	163437	149262	92100	74808	60763										
	1.52	193471	179124	179116	156104	96321	78237	63548										
	1.37	167759	153155	152983	141366	111335	90432	73454										
	1.18	167759	153155	152852	141245	111335	90432	73454										
0.98	167759	153155	152700	141104	111335	90432	73454											
0.83	146105	132811	132426	122370	101867	89406	72620											
0.68	114336	105653	95179	87951	73215	68533	67141											

5-6

5,6 stadi/stages/stufen
A richiesta / On request / Auf Anfrage

P _{TN}	PS PSB	S-SB-SU FS-FSR-SFD
16001	203.0	123.2
16002	125.2	91.0
16003	82.9	63.0
16004	64.5	49.6

1.2 Prestazioni

1.2 Performances

1.2 Leistungen

		n ₂ X h								10000 Hours Life				T _{max} [Nm]
		T _N [Nm]								n ₁ [rpm]	n ₂ [rpm]	T _N [Nm]	P ₁ [kW]	
Stadio Stage Stufe	ir	10000	20000	50000	100000	500000	1000000	2000000						
4	159.10	176036	175899	175487	157336	97082	78855	64050	1400	8.80	163490	171.19	360000	
	174.97	193471	179124	179116	156701	96690	78536	63791		8.00	167541	159.49	360000	
	204.55	193471	179124	179116	156104	96321	78237	63548		6.84	174910	142.36	360000	
	224.54	193471	179124	179116	152935	94366	76649	62258		6.23	176221	130.64	360000	
	262.51	193471	179124	179116	156104	96321	78237	63548		5.33	179115	113.60	360000	
	311.55	193471	179124	179116	156104	96321	78237	63548		4.49	179118	95.70	360000	
	336.96	193471	179124	170036	156104	96321	78237	63548		4.15	173481	85.67	360000	
	369.89	193471	179124	179116	152935	94366	76649	62258		3.78	179119	80.57	360000	
	432.43	193471	179124	179116	156104	96321	78237	63548		3.24	179121	69.06	360000	
	468.15	167759	153155	153149	142161	111285	90392	73421		2.99	153153	54.49	280000	
	513.21	193471	179124	179116	156104	96321	78237	63548		2.73	179122	58.19	360000	
	555.60	167759	153155	153149	141959	108612	88220	71657		2.52	153154	45.92	280000	
	629.85	169218	156367	140866	130168	94409	76684	62287		2.22	154497	40.81	360000	
	649.55	167759	153155	153149	141788	111601	90648	73629		2.16	153155	39.36	280000	
	797.17	167759	153155	153149	141585	111335	90432	73454		1.76	157288	32.94	280000	
	918.60	161938	151035	146619	139403	108612	88220	71657		1.52	154347	27.92	280000	
	1041.35	168344	155560	140139	129497	94409	76684	62287		1.34	162762	25.95	360000	
	1110.53	167759	153155	152908	141296	111335	90432	73454		1.26	163370	24.49	280000	
	1317.99	167759	153155	152766	141165	111335	90432	73454		1.06	166604	21.01	280000	
	1545.23	146105	132811	132478	122418	101907	89406	72620		0.91	147764	16.00	230000	
1896.42	114376	105690	95212	87982	73241	68557	67164	0.74	117926	10.38	155000			

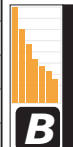

P_{TN}	PS PSB	S-SB-SU FS-FSR-SFD
16004	53.4	42.6

1.2 Prestazioni

1.2 Performances

1.2 Leistungen

EX		n ₂ X h							10000 Hours Life				T _{max} [Nm]	
Stadio Stage Stufe	ir	T _N [Nm]							n ₁ [rpm]	n ₂ [rpm]	T _N [Nm]	P ₁ [kW]		
		10000	20000	50000	100000	500000	1000000	2000000						
1	4.18	218187	202007	201998	201983	151593	123132	100014	500		119.62	116690	1506.82	410000
	4.89	195560	179339	179332	179319	148967	120999	98282			102.25	120194	1326.69	360000
	6.00*	177096	160983	160977	160967	135218	119208	96827			83.33	121569	1093.58	280000
2	17.49	218187	202007	201998	201983	128392	104287	84707	1000		57.18	123329	785.56	410000
	20.44	218187	202007	201998	201983	126780	102978	83644			48.92	127611	695.41	410000
	23.90	195560	179339	179332	179319	141430	114877	93309			41.84	149195	695.37	360000
	25.09	218187	202007	201998	201684	124446	101081	82104			39.86	133205	591.46	410000
	29.33	195560	179339	179332	179319	138826	112762	91591			34.09	155724	591.36	360000
	36.00*	177096	160983	160977	150850	125575	118053	96827			27.78	133073	411.80	280000
3	63.39	218187	202007	201998	201983	128392	104287	84707	1400		22.09	164058	412.48	410000
	69.95	218187	202007	201998	201983	128392	104287	84707			20.01	168977	384.84	410000
	74.11	218187	202007	201998	201983	126780	102978	83644			18.89	169772	365.01	410000
	81.78	218187	202007	201998	201983	126780	102978	83644			17.12	174863	340.73	410000
	90.94	218187	202007	201998	201983	128392	104287	84707			15.39	182818	320.23	410000
	109.30	217537	202007	201998	201983	128392	104287	84707			12.81	193187	281.67	410000
	127.78	216925	202007	201998	201983	126780	102978	83644			10.96	199914	249.38	410000
	156.82	216191	202007	201998	196807	124446	101081	82104			8.93	199368	202.64	410000
	183.33	195560	179339	179332	176290	138826	112762	91591			7.64	179325	155.93	360000
	225.00*	177096	160983	157535	145572	121182	113923	96827			6.22	153658	108.78	280000
4	221.87	215106	202007	201998	172281	106303	86345	70134	1400		6.31	197801	146.85	410000
	244.83	214831	202007	201998	184571	113886	92505	75137			5.72	201996	135.94	410000
	259.39	214676	202007	201998	192189	118587	96323	78238			5.40	201997	128.34	410000
	288.55	214401	202007	201998	183072	112962	91753	74527			4.85	201998	115.26	410000
	327.53	214093	202007	201998	166104	102492	83249	67619			4.27	202000	101.48	410000
	361.41	213867	202007	201998	177953	109803	89188	72443			3.87	202001	91.98	410000
	380.36	213754	202007	199995	162447	100235	81416	66131			3.68	202002	87.46	410000
	422.52	213530	202007	201998	198517	122492	99494	80814			3.31	202003	78.67	410000
	469.83	213316	202007	201998	201983	128392	104287	84707			2.98	202004	70.82	410000
	490.67	213231	202007	201998	194146	119795	97304	79035			2.85	202004	67.73	410000
	564.70	212970	202007	201998	201983	128392	104287	84707			2.48	202006	58.94	410000
	655.79	212712	202007	201998	201983	128392	104287	84707			2.13	202007	50.62	410000
	766.67	212462	202007	201998	201983	126780	102978	83644			1.83	202008	43.49	410000
	810.23	212378	202007	201998	191504	124446	101081	82104			1.73	202008	41.12	410000
	940.91	212163	202007	201998	191203	124446	101081	82104			1.49	208486	36.55	410000
	1136.93	211912	202007	201998	190852	124446	101081	82104			1.23	211910	30.67	410000
	1329.17	195560	179339	179332	173234	138826	112762	91591			1.05	194401	24.02	360000
	1631.25*	177096	160983	155119	143340	119324	112176	96827			0.86	180222	18.24	280000

5-6 5,6 stadi/stages/stufen
A richiesta / On request / Auf Anfrage

P _{EN}	PS PSB	S-SB-SU FS-FSR-SFD
20001	203.0	123.2
20002	130.3	96.1
20003	89.6	69.6
20004	71.6	56.6

1.2 Prestazioni

1.2 Performances

1.2 Leistungen

EXB		n ₂ X h								10000 Hours Life				T _{max} [Nm]
Stadio Stage Stufe	ir	T _N [Nm]								n ₁ [rpm]	n ₂ [rpm]	T _N [Nm]	P ₁ [kW]	
		10000	20000	50000	100000	500000	1000000	2000000	4					
4	160.35	216115	202007	201998	201983	128392	104287	84707	1400	8.73	201987	209.82	410000	
	176.93	215792	202007	201998	201983	128392	104287	84707			7.91	201989	190.12	410000
	206.85	215310	202007	201998	201983	126780	102978	83644			6.77	201993	162.72	410000
	230.01	215004	202007	201998	201983	128392	104287	84707			6.09	201995	146.38	410000
	268.90	214582	202007	201998	201983	126780	102978	83644			5.21	201997	125.23	410000
	308.80	214234	202007	201998	201983	126780	102978	83644			4.53	201999	108.88	410000
	340.74	214001	202007	201998	201983	126780	102978	83644			4.11	202001	98.79	410000
	378.90	213762	202007	201998	201983	128392	104287	84707			3.69	202002	88.69	410000
	418.18	213552	202007	201998	193144	124446	101081	82104			3.35	202003	80.52	410000
	455.41	213378	202007	201998	201983	128392	104287	84707			3.07	202004	73.79	410000
	532.41	213078	202007	201998	201983	126780	102978	83644			2.63	202005	63.22	410000
	653.41	212718	202007	201998	191980	124446	101081	82104			2.14	202007	51.44	410000
	752.94	208792	192937	186470	178965	128392	104287	84707			1.86	194546	43.06	410000
	880.25	212257	202007	201998	201983	126780	102978	83644			1.59	206902	39.14	410000
	1080.30	211978	202007	201998	190944	124446	101081	82104			1.30	211808	32.76	410000
	1262.96	195560	179339	179332	173281	138826	112762	91591			1.11	193268	25.53	360000
	1550.00*	177096	160983	155156	143374	119352	112203	96827			0.90	179171	19.19	280000

(*) NOTA
- Non disponibili per le versioni

PS-PN1
SD-SN1

(*) NOTE
- Not available for versions

PS-PN1
SD-SN1

(*) HINWEIS
- Nicht verfügbar für die Ausführungen

PS-PN1
SD-SN1

P_{EN}	PS PSB	S-SB-SU FS-FSR-SFD
20004	58.6	47.7

1.2 Prestazioni

1.2 Performances

1.2 Leistungen

EX		n ₂ X h								10000 Hours Life				T _{max} [Nm]
Stadio Stage Stufe	ir	T _N [Nm]								n ₁ [rpm]	n ₂ [rpm]	T _N [Nm]	P ₁ [kW]	
		10000	20000	50000	100000	500000	1000000	2000000						
3	61.30	313325	290090	290077	236214	145752	118387	96160	1400	22.84	184376	479.30	580000	
	67.64	313325	290090	286503	232713	143592	116633	94735			20.70	187087	440.78	580000
	71.66	313325	290090	290077	239424	147733	119996	97467			19.54	195845	435.56	580000
	79.07	313325	290090	290077	239424	147733	119996	97467			17.71	201712	406.59	580000
	87.93	313325	290090	282286	229287	141478	114916	93341			15.92	199426	361.35	580000
	97.04	306892	290090	261347	235732	145455	118146	95964			14.43	211186	346.85	580000
	111.29	276461	252394	252384	242976	166844	135519	110076			12.58	236705	338.92	435000
	123.55	313325	290090	290077	239424	147733	119996	97467			11.33	230612	297.39	580000
	133.76	276461	252394	252384	242190	163664	132936	107978			10.47	240935	287.11	435000
	151.63	306892	286575	258165	235732	145455	118146	95964			9.23	240739	252.90	580000
	191.91	276461	252394	252384	240840	171533	139328	113170			7.30	249652	207.43	435000
	225.00	248095	225521	225513	215164	179113	149272	121247			6.22	225509	159.65	352000
	276.14*	203223	187790	169173	156326	130134	121811	119337			5.07	168906	97.47	230000
4	214.53	313325	290090	283977	230661	142326	115604	93900	1400	6.53	262169	201.42	580000	
	250.81	313325	290090	290077	239424	147733	119996	97467			5.58	285189	187.23	580000
	276.75	313325	290090	290077	239424	147733	119996	97467			5.06	290077	172.69	580000
	295.60	313325	290090	290077	239424	147733	119996	97467			4.74	290078	161.77	580000
	326.17	313325	290090	290077	239424	147733	119996	97467			4.29	290080	146.41	580000
	362.70	313325	290090	282286	229287	141478	114916	93341			3.86	290082	131.74	580000
	408.54	313325	290090	290077	239424	147733	119996	97467			3.43	290084	117.06	580000
	435.94	313325	290090	276905	224917	138781	112726	91562			3.21	290085	109.56	580000
	474.43	313325	290090	290077	239424	147733	119996	97467			2.95	290086	100.68	580000
	509.65	313325	290090	290077	239424	147733	119996	97467			2.75	290087	93.86	580000
	531.10	313325	290090	290077	239424	147733	119996	97467			2.64	290087	90.10	580000
	616.77	313325	290090	290077	239424	147733	119996	97467			2.27	290089	77.48	580000
	741.30	313325	290090	290077	239424	147733	119996	97467			1.89	290090	64.51	580000
	824.96	276461	252394	252384	237300	171533	139328	113170			1.70	260223	52.05	435000
	895.74	313325	290090	290077	239424	147733	119996	97467			1.56	297713	54.64	580000
	991.54	276461	252394	252384	237010	171533	139328	113170			1.41	265759	44.09	435000
	1099.32	300352	277544	250029	231042	145455	118146	95964			1.27	292191	43.66	580000
	1391.36	276461	252394	252384	236542	171533	139328	113170			1.01	276265	32.83	435000
	1631.25	248095	225521	225513	211669	176204	149272	121247			0.86	252473	25.55	352000
	2001.99*	200288	185079	166731	154069	128255	120052	117614			0.70	208204	17.15	230000

5-6 5,6 stadi/stages/stufen
A richiesta / On request / Auf Anfrage

P _{TN}	PS PSB	S-SB-SU FS-FSR-SFD
25003	111.4	84.1
25004	90.1	69.6

1.2 Prestazioni

1.2 Performances

1.2 Leistungen

EXB		n ₂ X h								10000 Hours Life				T _{max} [Nm]
Stadio Stage Stufe	ir	T _N [Nm]								n ₁ [rpm]	n ₂ [rpm]	T _N [Nm]	P ₁ [kW]	
		10000	20000	50000	100000	500000	1000000	2000000	2000000					
4	155.04	256160	255965	255381	236214	145752	118387	96160	1400	9.03	243556	261.70	580000	
	171.08	282637	282400	281688	232713	143592	116633	94735			8.18	247139	240.55	580000
	200.01	313325	290090	290077	239424	147733	119996	97467			7.00	266467	221.95	580000
	222.40	313325	290090	282286	229287	141478	114916	93341			6.29	263440	197.17	580000
	260.01	313325	290090	290077	239424	147733	119996	97467			5.38	288287	184.55	580000
	312.51	313325	290090	290077	239424	147733	119996	97467			4.48	290079	154.64	580000
	329.47	291477	277724	250192	239424	147733	119996	97467			4.25	254873	128.89	580000
	366.36	313325	290090	277350	229287	141478	114916	93341			3.82	283414	128.82	580000
	428.31	313325	290090	290077	239424	147733	119996	97467			3.27	290085	112.87	580000
	463.69	276461	252394	252384	238401	166844	135519	110076			3.02	252391	90.70	435000
	514.79	313325	290090	290077	239424	147733	119996	97467			2.72	290087	93.89	580000
	557.32	276461	252394	252384	238015	163664	132936	107978			2.51	252393	75.38	435000
	631.79	302204	279255	251571	232467	145455	118146	95964			2.22	276012	72.91	580000
	665.29	276461	252394	252384	237675	171533	139328	113170			2.10	252394	63.07	435000
	799.63	276461	252394	252384	237352	171533	139328	113170			1.75	259296	53.99	435000
	851.13	232747	215509	209671	200119	147733	119996	97467			1.64	219916	42.92	580000
	921.43	249705	232961	226127	214965	163664	132936	107978			1.52	238082	43.06	435000
	1077.23	276461	252394	252384	236888	174219	141510	114942			1.30	268292	41.50	435000
	1322.06	276461	252394	252384	236607	171533	139328	113170			1.06	274655	34.64	435000
	1550.00	248095	225521	225513	211722	176249	149272	121247			0.90	251002	26.88	352000
1902.27*	200333	185120	166768	154104	128284	120079	117640	0.74	206647	18.20	230000			



(*) NOTA
- Non disponibili per le versioni

PS-PN1
SD-SN1

(*) NOTE
- Not available for versions

PS-PN1
SD-SN1

(*) HINWEIS
- Nicht verfügbar für die Ausführungen

PS-PN1
SD-SN1

P_{TN}	PS PSB	S-SB-SU FS-FSR-SFD
25004	72.0	57.1

1.2 Prestazioni

1.2 Performances

1.2 Leistungen

EX 		n ₂ X h								10000 Hours Life				T _{max} [Nm]									
Stadio Stage Stufe	ir	T _N [Nm]								n ₁ [rpm]	n ₂ [rpm]	T _N [Nm]	P ₁ [kW]										
		10000	20000	50000	100000	500000	1000000	2000000															
1	4.04	313325	290090	290077	290055	191525	155567	126360	500	123.76	145929	1949.61	580000										
	5.12	276461	252394	252384	252368	186376	151384	122962						97.66	152465	1607.35	435000						
	6.00	248095	225521	225513	225499	183776	149272	121247						83.33	157664	1418.27	352000						
	7.36*	225614	208482	187813	173551	144473	135233	119418						67.93	133191	976.70	230000						
2	16.91	313325	290090	290077	245046	151201	122814	99756	1000	59.14	143777	947.20	580000										
	19.77	313325	290090	290077	239424	147733	119996	97467						50.58	147221	829.50	580000						
	21.40	276461	252394	252384	252368	178310	144833	117641						46.73	181967	947.23	435000						
	25.02	276461	252394	252384	252368	174219	141510	114942						39.97	186326	829.61	435000						
	30.71	276461	252394	252384	250941	171533	139328	113170						32.56	195085	707.58	435000						
	36.00	248095	225521	225513	223408	183776	149272	121247						27.78	196987	609.59	352000						
	44.18*	210172	194212	174958	161672	134584	125977	119418						22.63	146057	368.19	230000						
	59.52	313325	290090	290077	245046	151201	122814	99756						23.52	189586	507.52	580000						
3	67.64	313325	290090	290077	245046	151201	122814	99756	1400	20.70	197001	464.14	580000										
	75.33	276461	252394	252384	244898	178310	144833	117641						18.58	228200	482.58	435000						
	79.57	313325	290090	290077	245046	151201	122814	99756						17.59	206839	414.10	580000						
	93.03	313325	290090	290077	239424	147733	119996	97467						15.05	211795	362.79	580000						
	98.85	313325	290090	290077	245046	151201	122814	99756						14.16	220750	355.77	580000						
	115.57	313325	290090	290077	239424	147733	119996	97467						12.11	226038	311.55	580000						
	125.11	276461	252394	252384	242468	178310	144833	117641						11.19	239381	304.88	435000						
	141.83	306892	287058	258600	235732	145455	118146	95964						9.87	236652	265.85	580000						
	179.51	276461	252394	252384	241072	171533	139328	113170						7.80	247998	220.17	435000						
	210.46	248095	225521	225513	215352	179271	149272	121247						6.65	225508	170.68	352000						
	258.29*	203381	187937	169305	156448	130236	121906	119418						5.42	167755	103.49	230000						
	4	208.32	313325	290090	278194	225963	139427	113250						91988	1400	6.72	254577	201.28	580000				
		236.73	313325	290090	290077	245046	151201	122814						99756						5.91	286869	199.47	580000
		279.00	313325	290090	290077	245046	151201	122814						99756						5.02	290077	171.33	580000
328.24		313325	290090	290077	245046	151201	122814	99756	4.27	290080	145.73	580000											
359.52		313325	290090	290077	239424	147733	119996	97467	3.89	290082	132.76	580000											
411.12		313325	290090	290077	245046	151201	122814	99756	3.41	290084	116.38	580000											
431.52		313325	290090	259858	211070	130238	105786	85925	3.24	290085	110.58	580000											
477.43		313325	290090	290077	245046	151201	122814	99756	2.93	290086	100.00	580000											
510.74		313325	290090	290077	245046	151201	122814	99756	2.74	290087	93.52	580000											
558.16		313325	290090	290077	239424	147733	119996	97467	2.51	290088	85.67	580000											
597.10		313325	290090	290077	239424	147733	119996	97467	2.34	290089	79.86	580000											
674.44		313325	290090	290077	239424	147733	119996	97467	2.08	290090	70.99	580000											
716.69		313325	290090	290077	245046	151201	122814	99756	1.95	290090	66.55	580000											
837.86		313325	290090	290077	239424	147733	119996	97467	1.67	290091	57.00	580000											
907.08		276461	252394	252384	237147	178310	144833	117641	1.54	263065	47.66	435000											
1028.29		300550	277726	250193	231194	145455	118146	95964	1.36	290166	46.43	580000											
1301.46		276461	252394	252384	236628	171533	139328	113170	1.08	274161	34.84	435000											
1525.85		248095	225521	225513	211739	176263	149272	121247	0.92	250551	27.12	352000											
1872.63*		200347	185133	166779	154114	128293	120088	117649	0.75	206172	18.19	230000											

5-6

5,6 stadi/stages/stufen
A richiesta / On request / Auf Anfrage

P _{TN}	PS PSB	S-SB-SU FS-FSR-SFD
26001	264.6	155.4
26002	167.6	120.8
26003	111.4	84.1
26004	90.1	69.6

1.2 Prestazioni

1.2 Performances

1.2 Leistungen

		n ₂ X h								10000 Hours Life				T _{max} [Nm]
		T _N [Nm]								n ₁ [rpm]	n ₂ [rpm]	T _N [Nm]	P ₁ [kW]	
Stadio Stage Stufe	ir	10000	20000	50000	100000	500000	1000000	2000000						
4	150.55	248745	248562	248011	245046	151201	122814	99756	1400	9.30	247222	273.58	580000	
	171.08	282637	282400	281688	245046	151201	122814	99756		8.18	260236	253.30	580000	
	201.27	313325	290090	290077	245046	151201	122814	99756		6.96	273239	226.29	580000	
	235.30	313325	290090	290077	239424	147733	119996	97467		5.95	279779	198.08	580000	
	250.04	313325	290090	290077	245046	151201	122814	99756		5.60	290074	193.29	580000	
	292.32	313325	290090	290077	239424	147733	119996	97467		4.79	290078	165.33	580000	
	331.55	293319	279279	251592	245046	151201	122814	99756		4.22	256483	128.79	580000	
	387.61	313325	290090	290077	239424	147733	119996	97467		3.61	290083	124.61	580000	
	411.89	313325	290090	290077	245046	151201	122814	99756		3.40	290084	117.36	580000	
	481.53	313325	290090	290077	239424	147733	119996	97467		2.91	290086	100.45	580000	
	521.31	276461	252394	252384	238151	178310	144833	117641		2.69	252392	80.79	435000	
	590.97	302464	279495	251787	232667	145455	118146	95964		2.37	274155	77.31	580000	
	714.53	248095	225521	225513	212724	177082	149272	121247		1.96	225522	52.60	352000	
	747.96	276461	252394	252384	237466	171533	139328	113170		1.87	252395	56.16	435000	
	876.92	248095	225521	225513	212420	176829	149272	121247		1.60	235161	44.77	352000	
	1007.63	270294	252394	246125	232823	174219	141510	114942		1.39	260353	43.06	435000	
	1181.36	248095	225521	225513	212030	176505	149272	121247		1.19	243320	34.45	352000	
	1236.63	276461	252394	252384	236696	171533	139328	113170		1.13	272563	36.65	435000	
	1449.85	248095	225521	225513	211794	176309	149272	121247		0.97	249090	28.75	352000	
	1779.36*	200393	185176	166818	154150	128323	120115	117676		0.79	204632	19.24	230000	

(*) NOTA
- Non disponibili per le versioni

PS-PN1
SD-SN1

(*) NOTE
- Not available for versions

PS-PN1
SD-SN1

(*) HINWEIS
- Nicht verfügbar für die Ausführungen

PS-PN1
SD-SN1

P_{TN}	PS PSB	S-SB-SU FS-FSR-SFD
26004	72.0	57.1

1.2 Prestazioni

1.2 Performances

1.2 Leistungen

EX 		n ₂ X h								10000 Hours Life				T _{max} [Nm]
Stadio Stage Stufe	ir	T _N [Nm]								n ₁ [rpm]	n ₂ [rpm]	T _N [Nm]	P ₁ [kW]	
		10000	20000	50000	100000	500000	1000000	2000000						
3	61.30	344758	333705	290813	236214	145752	118387	96160	1400	1400	22.84	184376	479.30	650000
	67.64	343898	333705	286503	232713	143592	116633	94735			20.70	187087	440.78	650000
	77.58	342767	333705	333690	278564	171884	139613	113401			18.05	233352	479.40	650000
	85.60	342001	333705	333690	274436	169336	137544	111720			16.36	236780	440.90	650000
	90.70	331405	303916	303903	303883	191746	155746	126505			15.44	272810	479.42	540000
	106.33	331405	303916	303903	303883	206019	167339	135922			13.17	299143	448.41	540000
	117.33	331405	303916	303903	303883	206019	167339	135922			11.93	301968	410.02	540000
	130.47	339110	333705	333690	299300	184678	150005	121842			10.73	293036	357.87	650000
	156.82	338025	333705	333690	296483	182940	148593	120695			8.93	306748	311.78	650000
	183.33	331405	303916	303903	303883	204080	165764	134642			7.64	303892	264.25	540000
	225.00	331405	303916	287225	265414	202414	164412	133544			6.22	280157	198.34	540000
	276.14*	300721	273359	272083	251421	209296	189754	154128			5.07	271653	156.76	410000
4	214.53	336391	333705	283977	230661	142326	115604	93900	1400	1400	6.53	262169	201.42	650000
	250.81	331405	303916	303903	257315	158772	128963	104751			5.58	303901	199.51	540000
	271.53	335320	333705	333690	272016	167843	136331	110735			5.16	331819	201.45	650000
	299.61	334909	333705	333690	274436	169336	137544	111720			4.67	333692	183.35	650000
	320.01	334644	333705	332172	269807	166480	135224	109836			4.37	333693	171.57	650000
	353.12	334265	333705	333690	274436	169336	137544	111720			3.96	333695	155.47	650000
	400.82	333804	333705	322884	262263	161825	131443	106765			3.49	333698	137.02	650000
	442.29	333466	333453	333414	274436	169336	137544	111720			3.17	333438	124.36	650000
	465.47	333297	333284	315775	256489	158262	128549	104414			3.01	333270	118.02	650000
	527.56	332900	332887	282286	229287	141478	114916	93341			2.65	332878	103.79	650000
	562.45	332706	332693	312819	254088	156781	127346	103437			2.49	332687	97.46	650000
	620.63	332421	332408	332369	272214	167965	136430	110816			2.26	332404	88.39	650000
	674.11	332191	332178	332139	299300	184678	150005	121842			2.08	332177	81.29	650000
	727.64	331988	331975	331936	299300	184678	150005	121842			1.92	331976	74.99	650000
	810.23	331714	331701	331662	296483	182940	148593	120695			1.73	331705	67.52	650000
	940.91	331358	331345	331306	296483	182940	148593	120695			1.49	331351	58.09	650000
	1136.93	330943	330930	330891	296483	182940	148593	120695			1.23	330940	47.89	650000
	1350.00	331405	303916	279046	257856	202414	164412	133544			1.04	330028	40.38	540000
	1631.25	331405	303916	278534	257383	202414	164412	133544			0.86	337254	34.12	540000
	2001.99*	300721	273359	268084	247726	206220	189754	154128			0.70	313286	25.80	410000

5-6 5,6 stadi/stages/stufen
A richiesta / On request / Auf Anfrage

P _{TN}	PS PSB	S-SB-SU FS-FSR-SFD
30003	115.3	88.0
30004	93.1	72.6

1.2 Prestazioni

1.2 Performances

1.2 Leistungen

EXB		n ₂ X h								10000 Hours Life				T _{max} [Nm]
Stadio Stage Stufe	ir	T _N [Nm]								n ₁ [rpm]	n ₂ [rpm]	T _N [Nm]	P ₁ [kW]	
		10000	20000	50000	100000	500000	1000000	2000000	1400					
4	155.04	256160	255965	255381	236214	145752	118387	96160	9.03	243556	261.70	650000		
	171.08	282637	282400	281688	232713	143592	116633	94735	8.18	247139	240.55	650000		
	196.23	324144	323832	322897	278564	171884	139613	113401	7.13	308260	261.53	650000		
	216.53	336346	333705	333690	274436	169336	137544	111720	6.47	312794	240.81	650000		
	230.06	336060	333705	333690	299300	184678	150005	121842	6.09	333685	241.81	650000		
	253.86	335613	333705	333690	299300	184678	150005	121842	5.51	333688	218.78	650000		
	281.49	335167	333705	332897	270396	166844	135519	110076	4.97	333427	197.18	650000		
	338.33	334428	333705	326552	265242	163664	132936	107978	4.14	333695	164.39	650000		
	396.66	333841	333705	333690	296483	182940	148593	120695	3.53	333698	140.17	650000		
	418.18	333657	333644	315702	299300	184678	150005	121842	3.35	323500	128.95	650000		
	463.69	333309	333296	332897	270396	166844	135519	110076	3.02	333283	119.77	650000		
	543.64	332808	332795	332756	299300	184678	150005	121842	2.58	332788	102.16	650000		
	653.41	332277	332264	332225	296483	182940	148593	120695	2.14	332262	84.61	650000		
	763.89	331405	303916	303903	301325	204080	165764	134642	1.83	303917	66.18	540000		
	801.91	293064	270809	243962	225436	181447	147381	119710	1.75	275036	57.27	650000		
	937.50	331405	303916	280180	258903	202414	164412	133544	1.49	316539	56.12	540000		
	1077.23	286775	271444	262132	246973	182576	148298	120455	1.30	278338	43.06	540000		
	1289.60	331405	303916	279177	257977	202414	164412	133544	1.09	328304	42.58	540000		
	1550.00	331405	303916	278668	257506	202414	164412	133544	0.90	335288	35.91	540000		
	1902.27*	300721	273359	268145	247782	206267	189754	154128	0.74	311459	27.42	410000		



(*) NOTA
- Non disponibili per le versioni

PS-PN1
SD-SN1

(*) NOTE
- Not available for versions

PS-PN1
SD-SN1

(*) HINWEIS
- Nicht verfügbar für die Ausführungen

PS-PN1
SD-SN1

P _{TN}	PS PSB	S-SB-SU FS-FSR-SFD
30004	74.2	59.3

1.2 Prestazioni

1.2 Performances

1.2 Leistungen

EX 		n ₂ X h							10000 Hours Life				T _{max} [Nm]
Stadio Stage Stufe	ir	T _N [Nm]							n ₁ [rpm]	n ₂ [rpm]	T _N [Nm]	P ₁ [kW]	
		10000	20000	50000	100000	500000	1000000	2000000					
1	4.18	360433	333705	333690	333665	253207	205668	167054	500	119.62	194908	2516.86	650000
	4.89	331405	303916	303903	303883	248793	202083	164142		102.25	200739	2215.75	540000
	6.00*	300721	273359	273349	273332	235288	199030	161662		83.33	210219	1891.03	410000
2	16.91	360433	333705	333690	312015	192524	156378	127018	500	29.57	225386	742.42	650000
	19.77	331405	303916	303903	303883	214771	174448	141696		25.29	263498	742.33	540000
	21.40	356967	333705	333690	303656	187366	152189	123616		23.36	235405	612.57	650000
	25.09	354718	333705	333690	299300	184678	150005	121842		19.93	243369	540.31	650000
	29.33	331405	303916	303903	303883	206019	167339	135922		17.05	284512	540.37	540000
	36.00	331405	303916	303903	283405	202414	164412	133544		13.89	261611	404.79	540000
	44.18*	300721	273359	273349	260168	216578	189754	154128		11.32	250761	316.21	410000
	59.52	345023	333705	333690	312015	192524	156378	127018		23.52	241399	646.22	650000
	67.64	343898	333705	333690	310284	191456	155510	126314		20.70	249449	587.71	650000
3	75.33	343004	333705	333690	303656	187366	152189	123616	18.58	252136	533.20	650000	
	85.60	342001	333705	333690	303656	187366	152189	123616	16.36	261991	487.84	650000	
	100.71	340814	333705	333690	303656	187366	152189	123616	13.90	275084	435.20	650000	
	118.07	339742	333705	333690	299300	184678	150005	121842	11.86	284387	383.89	650000	
	146.27	331405	303916	303903	303883	209018	169775	137900	9.57	303884	331.00	540000	
	171.49	331405	303916	303903	303883	206019	167339	135922	8.16	303890	282.24	540000	
	210.46	331405	303916	287691	265844	202414	164412	133544	6.65	278483	210.78	540000	
	258.29*	300721	273359	272299	251621	209462	189754	154128	5.42	269806	166.44	410000	
	208.32	336533	333705	278194	225963	139427	113250	91988	6.72	254577	201.28	650000	
	236.73	335928	333705	304235	247116	152479	123851	100598	5.91	289293	201.16	650000	
4	278.50	335212	333705	333690	276890	170850	138774	112719	5.03	333690	197.48	650000	
	328.24	334545	333705	333690	274642	169463	137647	111804	4.27	333694	167.64	650000	
	353.12	334265	333705	333690	289055	178357	144871	117671	3.96	333695	155.47	650000	
	411.12	333716	333703	328669	266962	164725	133798	108678	3.41	333684	133.87	650000	
	442.29	333466	333453	333414	280972	173370	140820	114381	3.17	333438	124.36	650000	
	477.43	333214	333201	321433	261085	161098	130852	106285	2.93	333189	114.86	650000	
	520.34	332942	332929	332890	303656	187366	152189	123616	2.69	332920	105.37	650000	
	576.90	332631	332618	318424	258640	159590	129627	105290	2.43	332613	95.09	650000	
	604.27	332497	332484	332445	303656	187366	152189	123616	2.32	332480	90.75	650000	
	730.15	331979	331966	331927	303656	187366	152189	123616	1.92	331967	74.99	650000	
	856.04	331580	331567	331528	299300	184678	150005	121842	1.64	331572	63.98	650000	
	1063.47	331085	331072	331033	299300	184678	150005	121842	1.32	331081	51.42	650000	
	1243.28	331405	303916	303903	300380	206019	167339	135922	1.13	326932	43.47	540000	
	1525.85	331405	303916	278709	257544	202414	164412	133544	0.92	334686	36.23	540000	
	1872.63*	300721	273359	268164	247800	206282	189754	154128	0.75	310900	27.43	410000	

5-6 5,6 stadi/stages/stufen
A richiesta / On request / Auf Anfrage

P _{TN}	PS PSB	S-SB-SU FS-FSR-SFD
31001	264.6	155.4
31002	174.4	127.6
31003	115.3	88.0
31004	93.1	72.6

1.2 Prestazioni

1.2 Performances

1.2 Leistungen

EXB		n ₂ X h								10000 Hours Life				T _{max} [Nm]
Stadio Stage Stufe	ir	T _N [Nm]								n ₁ [rpm]	n ₂ [rpm]	T _N [Nm]	P ₁ [kW]	
		10000	20000	50000	100000	500000	1000000	2000000						
4	150.55	248745	248562	248011	247093	192524	156378	127018	1400	9.30	247222	273.58	650000	
	171.08	282637	282400	281688	280503	191456	155510	126314			8.18	280934	273.45	650000
	201.27	332464	332136	331152	301935	186304	151326	122915			6.96	330510	273.72	650000
	216.53	336346	333705	333690	303656	187366	152189	123616			6.47	333683	256.89	650000
	254.74	335598	333705	333690	303656	187366	152189	123616			5.50	333688	218.38	650000
	298.66	334922	333705	333690	299300	184678	150005	121842			4.69	333692	186.22	650000
	316.46	334689	333705	333690	303656	187366	152189	123616			4.42	333693	175.50	650000
	349.16	331405	303916	303903	303422	206019	167339	135922			4.01	303907	145.01	540000
	371.03	334082	333705	333690	299300	184678	150005	121842			3.77	333696	149.69	650000
	419.63	333645	333632	316770	303656	187366	152189	123616			3.34	324620	129.01	650000
	491.98	333118	333105	333066	299300	184678	150005	121842			2.85	333094	112.96	650000
	521.31	332937	332923	332884	303656	187366	152189	123616			2.69	332915	106.56	650000
	575.16	331405	303916	303903	301993	206019	167339	135922			2.43	303914	87.88	540000
	611.19	332464	332451	332412	299300	184678	150005	121842			2.29	332447	90.59	650000
	705.88	331405	303916	281216	259861	202414	164412	133544			1.98	303916	71.60	540000
	876.92	331405	303916	280411	259117	202414	164412	133544			1.60	314128	59.81	540000
	1010.50	270977	254992	246787	233412	184678	150005	121842			1.39	261095	43.18	650000
	1181.36	311205	297017	285840	267688	206019	167339	135922			1.19	305242	43.22	540000
	1449.85	331405	303916	278847	257672	202414	164412	133544			0.97	332734	38.40	540000
	1779.36*	300721	273359	268227	247858	206330	189754	154128			0.79	309088	29.06	410000



(*) NOTA
- Non disponibili per le versioni

**PS-PN1
SD-SN1**

(*) NOTE
- Not available for versions

**PS-PN1
SD-SN1**

(*) HINWEIS
- Nicht verfügbar für die Ausführungen

**PS-PN1
SD-SN1**

P _{TN}	PS PSB	S-SB-SU FS-FSR-SFD
31004	74.2	59.3

1.2 Prestazioni

1.2 Performances

1.2 Leistungen

EX 		n ₂ X h							10000 Hours Life				T _{max} [Nm]
Stadio Stage Stufe	ir	T _N [Nm]							n ₁ [rpm]	n ₂ [rpm]	T _N [Nm]	P ₁ [kW]	
		10000	20000	50000	100000	500000	1000000	2000000					
2	17.49	360055	333705	333690	333665	253207	205668	167054	500	28.59	299442	953.66	650000
	20.44	357646	333705	333690	333665	250160	203193	165044					
	23.90	331405	303916	303903	303883	248793	202083	164142					
	25.09	354718	333705	333690	333665	246238	200007	162456					
	29.33	331405	303916	303903	303883	248793	202083	164142					
	36.00*	300721	273359	273349	261713	217864	199030	161662					
3	70.71	343524	333705	333690	327860	202301	164319	133469	1400	19.80	267113	601.96	650000
	82.67	342268	333705	333690	333665	225678	183307	148892					
	89.50	341667	333705	333690	321441	198340	161102	130856					
	104.63	340549	333705	333690	333665	221260	179719	145977					
	122.67	339496	333705	333690	333665	216862	176147	143076					
	150.55	338257	333705	333690	333665	246238	200007	162456					
	184.76	337138	333705	333690	333665	246238	200007	162456					
	216.00	331405	303916	303903	303883	248793	202083	164142					
	265.09*	300721	273359	272214	251542	209397	196855	161662					
4	247.49	335726	333705	313850	254926	157298	127766	103778	1400	5.66	302442	201.40	650000
	289.33	335052	333705	333690	284384	175475	142530	115770					
	313.23	334729	333705	333690	300631	185500	150673	122384					
	341.00	334398	333705	333690	282075	174050	141372	114830					
	369.17	334100	333705	333690	298190	183994	149449	121391					
	424.26	333607	333594	295936	240374	148319	120473	97854					
	462.39	333318	333305	333266	289853	178849	145270	117996					
	506.00	333029	333016	332977	332912	216862	176147	143076					
	540.58	332825	332812	332773	323347	199516	162057	131632					
	599.33	332520	332507	327042	265641	163909	133136	108140					
	648.84	332296	332283	332244	280817	173274	140742	114318					
	758.55	331880	331867	331828	313267	193297	157006	127528					
	889.33	331489	331476	331437	331372	216063	175498	142549					
	954.60	331325	331312	331273	331208	246238	200007	162456					
	1091.45	331029	331016	330977	330912	246238	200007	162456					
	1339.51	330614	330601	330562	330497	246238	200007	162456					
	1566.00	331405	303916	303903	300006	248793	202083	164142					
	1921.91*	300721	273359	268133	247771	206257	193903	161662					

5-6 5,6 stadi/stages/stufen
A richiesta / On request / Auf Anfrage

(*) NOTA
- Non disponibili per le versioni
PS-PN1
SD-SN1

(*) NOTE
- Not available for versions
PS-PN1
SD-SN1

(*) HINWEIS
- Nicht verfügbar für die Ausführungen
PS-PN1
SD-SN1

P _{TN}	PS PSB	S-SB-SU FS-FSR-SFD
32002	174.4	127.6
32003	119.5	92.2
32004	96.2	75.7

1.2 Prestazioni

1.2 Performances

1.2 Leistungen

EX		$n_2 \times h$							10000 Hours Life				T_{max} [Nm]					
Stadio Stage Stufe	ir	T_N [Nm]							n_1 [rpm]	n_2 [rpm]	T_N [Nm]	P_1 [kW]						
		10000	20000	50000	100000	500000	1000000	2000000										
1	4.17	429121	397272	397254	397225	263076	213684	173565	500	119.90	202358	2619.17	780000					
	4.65	404919	371449	371434	371408	260895	211913	172127										
	5.29	384299	351014	351000	350977	255307	207374	168440										
	6.21	343510	311204	311192	311173	254626	206821	167990										
2	17.45	428132	397272	397254	397225	254345	206592	167805	500	28.65	300581	959.30	780000					
	20.41	425082	397272	397254	397225	249828	202924	164825										
	22.73	404919	371449	371434	371408	260895	211913	172127										
	25.04	421399	397272	397253	397195	245912	199742	162241										
	27.90	404919	371449	371434	371408	260895	211913	172127										
	31.76	384299	351014	351000	340450	255307	207374	168440										
	37.29	343510	311204	311192	306482	254626	206821	167990										
	70.58	407216	383917	383883	327426	202033	164102	133292						1400	19.84	266612	602.05	780000
82.51	405623	382415	382381	365262	225379	183065	148695											
91.92	404919	371449	371434	371408	243081	197443	160373											
101.26	403709	380611	380577	380521	245912	199742	162241											
112.81	404919	371449	371434	371408	260895	211913	172127											
128.16	401734	378748	378714	378659	245912	199742	162241											
150.26	400524	377607	377574	377518	245912	199742	162241											
184.41	399100	376265	376232	376177	245912	199742	162241											
205.45	404919	371449	371434	371408	260895	211913	172127											
233.90	384299	351014	351000	325324	255307	207374	168440											
274.56	343510	311204	311192	293993	244736	206821	167990											
3	247.02	397304	374572	313435	254588	157090	127596	103641	1400	5.67	301870	201.38	780000					
	288.79	396446	373763	349654	284008	175242	142341	115617										
	312.64	396036	373376	369631	300234	185254	150473	122222										
	340.36	395614	372978	346815	281702	173819	141185	114678										
	368.47	395235	372621	366630	297796	183750	149251	121230										
	426.30	394578	372002	337118	273825	168959	137238	111472										
	461.52	394240	371683	356378	289469	178612	145078	117840										
	495.06	393952	371412	329696	267796	165239	134216	109017										
	541.09	393602	371081	371048	314636	194141	157691	128085										
	598.20	393224	370725	326609	265289	163692	132960	107997										
	647.61	392939	370457	345269	280446	173044	140556	114167										
	760.70	392394	369943	369910	367269	245912	199742	162241										
	864.90	404919	371449	371434	371408	260895	211913	172127										
	901.57	391865	369444	369411	347499	214418	174162	141463										
	988.90	404919	371449	371434	371408	232725	189031	153541										
	1061.47	404919	371449	371434	371408	260895	211913	172127										
	1106.47	391284	368896	368864	365680	245912	199742	162241										
	1232.67	404919	371449	371434	371408	260895	211913	172127										
	1336.98	390798	368438	368405	364983	245912	199742	162241										
	1489.48	404919	371449	371434	371408	260895	211913	172127										
	1695.80	384299	351014	345951	319680	255307	207374	168440										
	1990.55	343510	311204	311192	289353	240873	206821	167990										



5-6 5,6 stadi/stages/stufen
A richiesta / On request / Auf Anfrage

P_{TN}	PS PSB	S-SB-SU FS-FSR-SFD
37001	320.6	180.6
37002	208.0	148.0
37003	139.1	104.1
37004	110.9	84.6

1.2 Prestazioni

1.2 Performances

1.2 Leistungen

EX		n ₂ X h							10000 Hours Life				T _{max} [Nm]
		T _N [Nm]							n ₁ [rpm]	n ₂ [rpm]	T _N [Nm]	P ₁ [kW]	
Stadio Stage Stufe	ir	10000	20000	50000	100000	500000	1000000	2000000					
1	4.17	498641	461633	461612	461578	350767	284912	231420	500	119.90	269811	3492.24	910000
	4.84	474962	435703	435685	435655	344594	279897	227347		103.31	277180	3091.21	760000
	5.87	430532	391610	391595	391570	339589	275832	224045		85.18	289431	2661.38	610000
2	16.88	489791	461633	461612	461578	307078	249424	202596	500	29.62	359302	1185.53	910000
	19.58	474962	435703	435685	435655	340715	276747	224788		25.54	407135	1158.32	760000
	21.36	484570	461633	461612	461578	298871	242759	197181		23.41	375288	978.67	910000
	25.04	481332	461633	461612	461578	294777	239433	194480		19.97	388225	863.64	910000
	29.05	474962	435703	435685	435655	327067	265661	215784		17.21	421655	808.36	760000
	35.66	474962	435703	424900	392634	322179	261691	212559		14.02	361319	564.30	760000
	43.20	430532	391610	391595	387311	322418	275832	224045		11.57	371654	479.01	610000
3	70.58	465132	461633	461612	426408	263108	213710	173586	1400	19.84	347209	784.05	910000
	81.88	474962	435703	435685	435655	291929	237120	192601		17.10	402794	783.95	760000
	89.33	462438	461633	461612	461578	298871	242759	197181		15.67	423288	754.94	910000
	104.43	460816	460798	460743	460653	298871	242759	197181		13.41	443592	677.05	910000
	122.43	459287	459269	459215	452750	294777	239433	194480		11.44	445884	580.57	910000
	128.16	458869	458851	458797	458707	298160	242181	196712		10.92	458691	570.10	910000
	150.26	457487	457469	457415	449974	294777	239433	194480		9.32	453615	481.19	910000
	174.32	474962	435703	435685	435655	327067	265661	215784		8.03	435667	398.18	760000
	213.93	474962	435703	397002	366854	322179	261691	212559		6.54	385012	286.59	760000
	259.20	430532	391610	391595	373409	310845	275832	224045		5.40	391593	240.68	610000
4	262.55	453418	453400	453347	421351	259988	211176	171528	1400	5.33	453341	284.29	910000
	288.72	452831	452814	452760	419650	258938	210323	170836		4.85	452763	258.36	910000
	337.54	451925	451907	451854	418052	257953	209523	170185		4.15	451869	220.63	910000
	370.53	451417	451399	451346	409566	252716	205269	166730		3.78	451368	200.74	910000
	439.75	450543	450525	450472	399729	246646	200339	162726		3.18	450504	168.55	910000
	468.96	450234	450216	450163	450075	298025	242072	196623		2.99	450199	158.37	910000
	514.10	449809	449791	449738	418052	257953	209523	170185		2.72	449779	143.94	910000
	556.57	449457	449440	449387	449299	290867	236258	191901		2.52	449431	133.25	910000
	614.70	449037	449019	448966	436730	294777	239433	194480		2.28	449014	120.45	910000
	672.86	448671	448654	448601	448513	298160	242181	196712		2.08	448652	109.79	910000
	762.86	448191	448174	448121	435392	294777	239433	194480		1.84	448176	97.02	910000
	884.99	474962	435703	435685	434105	327067	265661	215784		1.58	450674	83.78	760000
	926.40	474962	435703	435685	433963	330821	268710	218261		1.51	453039	80.49	760000
	1086.12	474962	435703	435685	433491	327067	265661	215784		1.29	461361	70.02	760000
	1332.97	461987	426904	384582	355377	321889	261691	212559		1.05	459411	56.75	760000
1615.02	430532	391610	391595	367597	306007	275832	224045	0.87	437630	44.80	610000		

5-6 5,6 stadi/stages/stufen
A richiesta / On request / Auf Anfrage

P _{EN}	PS PSB	S-SB-SU FS-FSR-SFD
45001	320.6	180.6
45002	212.4	152.4
45003	146.2	111.2
45004	117.1	90.8

1.2 Prestazioni

1.2 Performances

1.2 Leistungen

EX		n ₂ X h							10000 Hours Life				T _{max} [Nm]
Stadio Stage Stufe	ir	T _N [Nm]							n ₁ [rpm]	n ₂ [rpm]	T _N [Nm]	P ₁ [kW]	
		10000	20000	50000	100000	500000	1000000	2000000					
1	4.17	603872	559054	559029	558987	432833	351570	285563	500	119.90	332936	4309.28	1150000
	4.65	588039	539433	539411	539374	428906	348380	282973		107.53	340877	3956.87	990000
	5.29	549663	502056	502036	502003	421026	341980	277774		94.52	347813	3548.91	860000
	6.21	521843	472764	472747	469914	391181	338659	275077		80.52	351509	3055.38	680000
2	17.45	603872	559054	559029	558987	405972	329752	267842	500	28.65	479772	1531.19	1150000
	20.41	603872	559054	559029	558987	398939	324040	263202		24.50	494151	1348.64	1150000
	22.73	588039	539433	539411	539374	428906	348380	282973		22.00	539285	1321.63	990000
	25.04	603872	559054	559029	558987	393036	319244	259307		19.97	499809	1111.86	1150000
	27.9	588039	539433	539411	539374	423905	344318	279673		17.92	539315	1076.59	990000
	31.76	549663	502056	502036	502003	421026	341980	277774		15.74	487651	855.03	860000
	37.29	521843	472764	468531	432951	360411	333042	275077		13.41	407449	608.65	680000
	3	72.99	603872	559054	559029	557245	343839	279284		226849	1000	13.70	507021
85.33		603872	559054	559029	558987	383572	311557	253063	11.72	558973		745.64	1150000
99.76		603872	559054	559029	558987	378756	307646	249886	10.02	558987		637.50	1150000
111.14		588039	539433	539411	539374	408504	331808	269512	9.00	539381		552.52	990000
122.43		603872	559054	559029	558987	371782	301981	245285	8.17	559002		519.81	1150000
150.26		603872	559054	559029	527010	393036	319244	259307	6.66	547104		414.72	1150000
167.4		588039	539433	539411	539374	423905	344318	279673	5.97	539404		366.52	990000
190.59		549663	502056	502036	502003	421026	341980	277774	5.25	502034		299.99	860000
223.71		521843	472764	449880	415717	346065	319785	275077	4.47	453611		230.78	680000
4		264.6	603872	559054	559029	557245	343839	279284	226849	1400		5.29	559026
	291.97	603872	559054	559029	557245	343839	279284	226849	4.80		559030	315.71	1150000
	309.33	603872	559054	559029	550249	339522	275778	224001	4.53		559033	297.95	1150000
	341.33	603872	559054	559029	550249	339522	275778	224001	4.10		559036	269.67	1150000
	379.56	603872	559054	559029	557245	343839	279284	226849	3.69		559040	242.70	1150000
	418.91	603872	559054	559029	540117	333271	270700	219877	3.34		559042	219.68	1150000
	443.73	603872	559054	559029	550249	339522	275778	224001	3.16		559044	207.85	1150000
	518.76	603872	559054	559029	558987	378756	307646	249886	2.70		559048	177.59	1150000
	533.33	603872	559054	559029	550249	339522	275778	224001	2.63		559048	172.99	1150000
	601.04	603872	559054	553721	511672	393036	319244	259307	2.33		559051	153.25	1150000
	654.55	603872	559054	559029	540117	333271	270700	219877	2.14		559052	140.76	1150000
	765.22	603872	559054	559029	558987	371782	301981	245285	1.83		559055	120.37	1150000
	852.5	588039	539433	539411	539374	400982	325699	264550	1.64		555585	107.20	990000
	939.13	603872	559054	550367	508573	393036	319244	259307	1.49		570303	99.98	1150000
	1046.25	588039	539433	539411	539374	423905	344318	279673	1.34		568761	89.67	990000
	1191.18	549663	502056	502036	496390	413221	341980	277774	1.18		539595	74.91	860000
	1398.21	521843	472764	442038	408470	340032	314210	275077	1.00		521767	61.39	680000



B

5-6 5,6 stadi/stages/stufen
A richiesta / On request / Auf Anfrage

P _{TN}	S-SB-SU FS-FSR-SFD
55001	232.4
55002	183.0
55003	132.0
55004	109.2

1.2 Prestazioni

1.2 Performances

1.2 Leistungen

EX 		n ₂ X h								10000 Hours Life				T _{max} [Nm]
Stadio Stage Stufe	ir	10000	20000	50000	100000	500000	1000000	2000000	η ₁ [rpm]	η ₂ [rpm]	T _N [Nm]	P ₁ [kW]		
1	4.17	719388	665997	665967	665917	577111	468760	380751	500	119.90	443915	5745.71	1350000	
	4.84	685413	628758	628732	628689	567004	460551	374083		103.31	456079	5086.36	1050000	
	5.87*	642181	584126	584103	584066	490718	451414	366662		85.18	437751	4025.22	820000	
2	16.88	719388	665997	665967	665917	512912	416614	338396	500	29.62	600143	1980.20	1350000	
	19.58	685413	628758	628732	628689	567004	460551	374083		25.54	615495	1751.11	1050000	
	21.36	719388	665997	665967	665917	499121	405412	329297		23.41	626738	1634.39	1350000	
	25.04	715342	665997	665967	665917	492159	399757	324704		19.97	648180	1441.92	1350000	
	29.05	685413	628758	628732	628689	546070	443547	360272		17.21	628627	1205.15	1050000	
	35.66	685413	628758	628732	628689	537835	436858	354839		14.02	628654	981.81	1050000	
	43.2*	642181	584126	582936	538669	448416	420501	366662		11.57	516335	665.48	820000	
3	70.58	690275	665997	665967	656241	404923	328900	267150	1000	14.17	591109	953.34	1350000	
	82.51	687453	665997	665967	641185	395633	321354	261021		12.12	605251	834.92	1350000	
	89.33	686098	665997	665967	665917	477522	387868	315047		11.19	665906	848.11	1350000	
	104.43	683582	665997	665967	665917	466566	378970	307819		9.58	665922	726.10	1350000	
	122.43	681211	665997	665967	665917	492159	399757	324704		8.17	665936	619.25	1350000	
	128.16	680562	665997	665967	665917	459373	373127	303073		7.80	665939	591.20	1350000	
	150.26	678418	665997	665967	665917	492159	399757	324704		6.66	665951	504.81	1350000	
	174.32	685413	628758	628732	628689	546070	443547	360272		5.74	628726	410.75	1050000	
	213.93	685413	628758	628732	628689	537835	436858	354839		4.67	628735	334.19	1050000	
	259.2*	642181	584126	561094	518485	431614	404745	366662		3.86	575484	252.83	820000	
	4	248.43	672652	665997	665967	656241	404923	328900		267150	1400	5.64	665961	441.91
282.31		671403	665997	665967	656241	404923	328900	267150	4.96	665967		388.63	1350000	
332.13		669925	665997	665967	656241	404923	328900	267150	4.22	665975		330.66	1350000	
388.28		668613	665997	665967	641185	395633	321354	261021	3.61	665981		282.86	1350000	
451.14		667446	665997	665967	665917	459373	373127	303073	3.10	665986		242.90	1350000	
482.37		666953	665997	665967	641185	395633	321354	261021	2.90	665988		227.23	1350000	
522.21		666389	665997	665967	665917	477522	387868	315047	2.68	665990		210.00	1350000	
592		665543	665517	665439	631300	389533	316399	256996	2.36	665507		184.79	1350000	
610.51		665343	665317	665239	665109	466566	378970	307819	2.29	665310		179.25	1350000	
715.77		664359	664333	664255	664125	492159	399757	324704	1.96	664334		153.20	1350000	
749.26		664091	664065	663986	663856	459373	373127	303073	1.87	664068		146.10	1350000	
878.45		663203	663177	663099	662969	492159	399757	324704	1.59	663187		124.06	1350000	
1019.08		685413	628758	628732	628689	544677	443547	360272	1.37	660949		106.54	1050000	
1078.1		662159	656578	591487	546570	484736	393728	319807	1.30	662151		101.28	1350000	
1250.69		685413	628758	628732	623431	537835	436858	354839	1.12	676624		89.16	1050000	
1515.32*		642181	584126	552144	510215	424729	398288	366662	0.92	648025		70.14	820000	

5-6 5,6 stadi/stages/stufen
A richiesta / On request / Auf Anfrage

(*) NOTA
- Non disponibili per le versioni
PS-PN1
SD-SN1

(*) NOTE
- Not available for versions
PS-PN1
SD-SN1

(*) HINWEIS
- Nicht verfügbar für die Ausführungen
PS-PN1
SD-SN1

P _{TN}	S-SB-SU FS-FSR-SFD
68001	232.4
68002	192.6
68003	144.0
68004	118.2

1.2 Prestazioni

1.2 Performances

1.2 Leistungen

EX		n ₂ X h							10000 Hours Life				T _{max} [Nm]
Stadio Stage Stufe	ir	T _N [Nm]							n ₁ [rpm]	n ₂ [rpm]	T _N [Nm]	P ₁ [kW]	
		10000	20000	50000	100000	500000	1000000	2000000					
2	14.98	914850	851086	851046	764538	471746	383177	311236	500	33.38	532551	1980.23	1500000
	18.95	914850	851086	851046	743981	459061	372874	302867		26.39	556101	1634.79	1500000
	22.22	822718	822679	820535	733603	452658	367672	298643		22.50	575166	1441.60	1500000
3	62.63	914850	851086	743083	603571	372424	302502	245708	500	7.98	645761	586.52	1500000
	73.22	914850	851086	726035	589724	363880	295562	240071		6.83	661221	514.02	1500000
	79.26	914850	851086	851046	711785	439196	356738	289761		6.31	815411	585.62	1500000
	92.67	914850	851086	851046	695455	429120	348553	283113		5.40	827001	508.29	1500000
	108.64	822718	822679	764695	706625	452658	367672	298643		4.60	751130	393.26	1500000
	113.73	914850	851086	843005	684733	422503	343179	278748		4.40	842758	422.05	1500000
	133.33	822718	822679	759768	702072	452658	367672	298643		3.75	765736	326.83	1500000
4	220.44	914850	851086	743083	603571	372424	302502	245708	1400	6.35	691635	516.72	1500000
	250.51	914850	851086	743083	603571	372424	302502	245708		5.59	718683	472.67	1500000
	279.01	914850	851086	832848	711785	439196	356738	289761		5.02	832512	491.70	1500000
	294.71	914850	851086	743083	603571	372424	302502	245708		4.75	754585	421.70	1500000
	317.05	914850	851086	830570	711785	439196	356738	289761		4.42	842414	438.08	1500000
	344.54	914850	851086	726035	589724	363880	295562	240071		4.06	772649	369.08	1500000
	373	914850	851086	827871	711785	439196	356738	289761		3.75	851063	375.49	1500000
	436.07	914850	851086	825470	695455	429120	348553	283113		3.21	851070	321.42	1500000
	541.74	914850	851086	822427	695455	429120	348553	283113		2.58	851078	258.34	1500000
	635.14	822718	815303	734476	678701	452658	367672	298643		2.20	806320	208.71	1500000
	664.86	914850	851086	819839	684733	422503	343179	278748		2.11	851085	211.28	1500000
	779.49	822718	812965	732370	676755	452658	367672	298643		1.80	822687	174.23	1500000
	5-6	5,6 stadi/stages/stufen A richiesta / On request / Auf Anfrage											

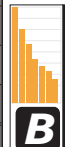

P _{TN}	S-SB-SU FS-FSR-SFD
75002	192.6
75003	144.0
75004	118.2

1.2 Prestazioni

1.2 Performances

1.2 Leistungen

EX		$n_2 \times h$							10000 Hours Life				T_{max} [Nm]						
Stadio Stage Stufe	ir	10000	20000	50000	100000	500000	1000000	2000000	n_1 [rpm]	n_2 [rpm]	T_N [Nm]	P_1 [kW]							
1	3.7	914850	851086	851046	850980	591161	480172	390021	500	135.14	438699	6399.93	1500000						
	2	15.49	914850	851086	851046	850980	591161	480172						390021	500	32.28	674095	2423.95	1500000
		18.11	914850	851086	851046	850980	591161	480172						390021		27.61	706450	2172.78	1500000
22.22	914850	851086	851046	850980	591161	480172	390021	22.50	751154	1882.70	1500000								
3	62.63	914850	851086	851046	768523	474204	385174	312858	500	7.98	822243	746.81	1500000						
	73.22	914850	851086	851046	850980	529002	429683	349011		6.83	851022	661.56	1500000						
	79.26	914850	851086	851046	747935	461501	374856	304477		6.31	851029	611.20	1500000						
	92.67	914850	851086	851046	834364	514831	418172	339662		5.40	851041	523.06	1500000						
	108.64	914850	851086	851046	822394	507445	412173	334789		4.60	851052	445.58	1500000						
	113.73	914850	851086	851046	826546	591161	480172	390021		4.40	851054	426.21	1500000						
	133.33	914850	851086	851046	808005	498567	404962	328931		3.75	851063	363.25	1500000						
	163.64	914850	851086	851046	817591	575416	467383	379633		3.06	851072	296.41	1500000						
4	220.44	914850	851086	851046	768523	474204	385174	312858	1400	6.35	851028	635.81	1500000						
	250.51	914850	851086	851046	764259	471574	383037	311123		5.59	851039	559.72	1500000						
	279.01	914850	851086	851046	747935	461501	374856	304477		5.02	851046	502.65	1500000						
	294.71	914850	851086	851046	743694	458885	372730	302751		4.75	851050	475.61	1500000						
	317.05	914850	851086	851046	747935	461501	374856	304477		4.42	851054	442.57	1500000						
	344.54	914850	851086	851046	829633	511912	415801	337736		4.06	851059	406.53	1500000						
	373	914850	851086	851046	747935	461501	374856	304477		3.75	851063	375.49	1500000						
	436.07	914850	851086	851046	834364	514831	418172	339662		3.21	851070	321.42	1500000						
	463.38	914850	851086	851046	747935	461501	374856	304477		3.02	851073	302.40	1500000						
	541.74	914850	851086	851046	834364	514831	418172	339662		2.58	851078	258.34	1500000						
	635.14	914850	851086	851046	822394	507445	412173	334789		2.20	851083	220.29	1500000						
	779.49	914850	851086	851046	808005	498567	404962	328931		1.80	851089	180.24	1500000						
	956.64	914850	851086	851046	790731	575416	467383	379633		1.46	875836	150.45	1500000						
5-6	5,6 stadi/stages/stufen A richiesta / On request / Auf Anfrage																		

P_{TN}	S-SB-SU FS-FSR-SFD
80001	232.4
80002	192.6
80003	147.9
80004	121.1